



PRODUCT SPECIFICATION

REV A January 2010

Oscilent Controlled Document

| Ordering Code / Part Number | Product Description |
|-----------------------------|----------------------------------|
| 862-RF1690.0M-A | Wireless, Balanced RF SAW Filter |

Specification Contents

- o Mechanical Dimensions
- o Test Circuit
- o Maximum Ratings
- o Electrical Specification
- o Frequency Performance
- o VSWR
- o Smith Chart

Notes

- o Electrostatic Sensitive Device (ESD) 
- o Avoid excessive ultrasonic exposure
- o Solderability compatible with JEDEC J-STD-020C Pb-free process, 260°C peak reflow temperature
- o This product complies with EU directive 2002/95/EC (RoHS compliance)





Mechanical Dimensions (mm)

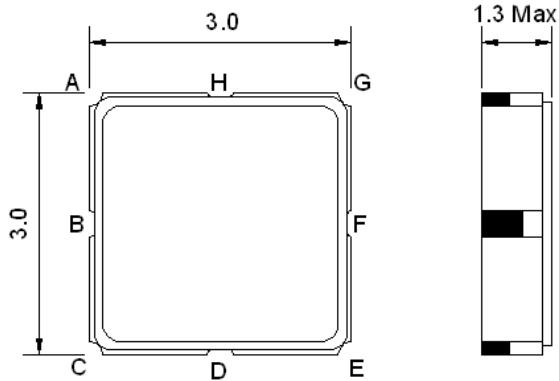

| Pin Description | |
|-----------------|--------|
| B, D, F, H | Ground |
| A, G | In |
| C, E | Out |

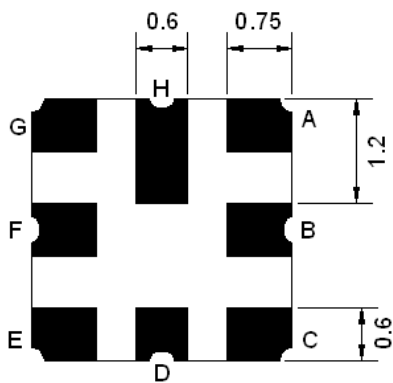

Test Circuit

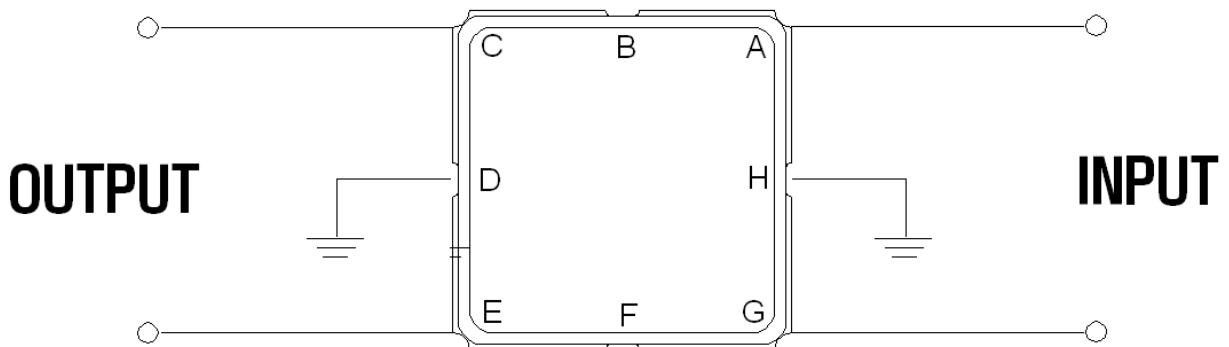

Source Impedance: 200 Ω

Load Impedance: 200 Ω

**Maximum Ratings**

| Parameters Description | Unit | Minimum | Typical | Maximum |
|--|------|---------|---------|---------|
| Operating Temperature Range | °C | -10 | - | +70 |
| Storage Temperature Range | °C | -40 | - | +85 |
| Maximum DC Voltage | V | - | - | 3 |
| Maximum Input Power | dBm | - | - | 0 |
| Source Impedance (balanced ended) ⁽¹⁾ | Ω | - | 200 | - |
| Load Impedance (balanced ended) ⁽¹⁾ | Ω | - | 200 | - |

Notes: No Matching Network

Electrical Specification

| Parameters Description | Unit | Minimum | Typical | Maximum |
|--|-------------------|---------|---------|---------|
| Center Frequency (Fo) | MHz | - | 1690.0 | - |
| Insertion Loss within 1679.7 ~ 1698.8 MHz | dB | - | 3.3 | 4.5 |
| Amplitude Ripple within 1679.7 ~ 1698.8 MHz | dB _{p-p} | - | 0.4 | 1.5 |
| Group Delay Ripple within 1679.7 ~ 1698.8 MHz | ns _{p-p} | - | 7.0 | 15.0 |
| Input / Output VSWR within 1679.7 ~ 1698.8 MHz | - | - | 2.10 | 2.50 |
| Attenuation: | | | | |
| 54.0 ~ 1100.0 MHz | dB | 45 | 54 | - |
| 3262.7 ~ 3352.6 MHz | dB | 18 | 22 | - |
| 4911.0 ~ 5009.0 MHz | dB | 25 | 32 | - |
| 6559.4 ~ 6665.1 MHz | dB | 18 | 22 | - |
| 8211.1 ~ 8319.4 MHz | dB | 20 | 28 | - |



Frequency Performance

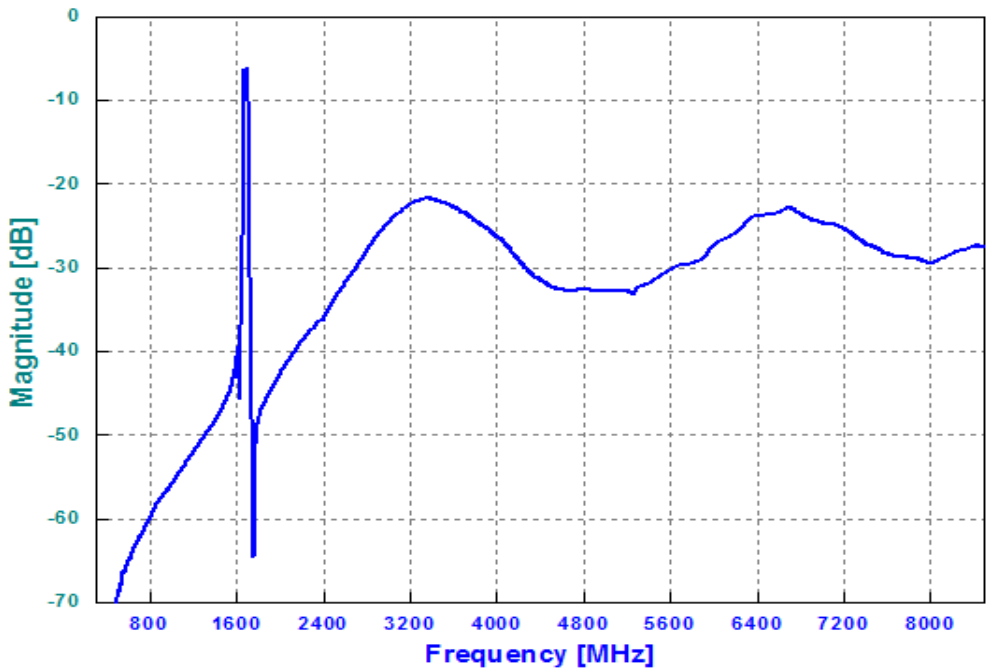
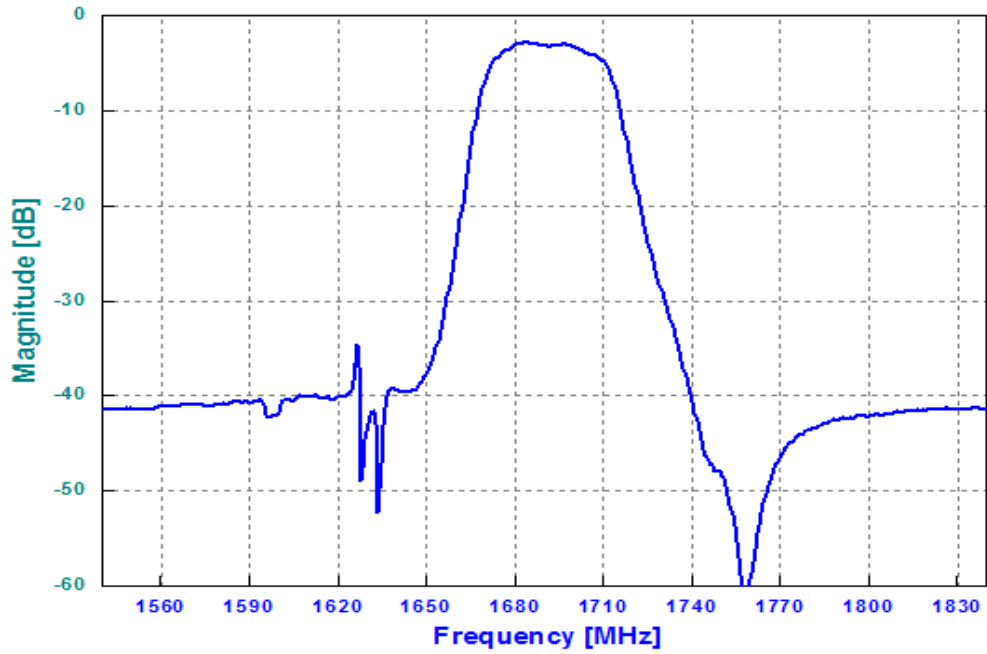



VSWR

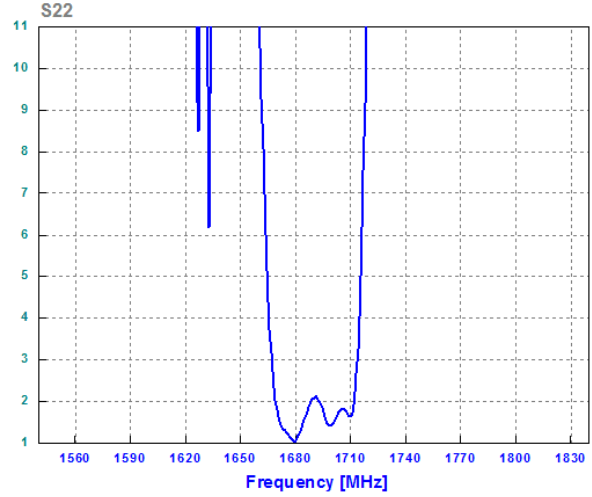
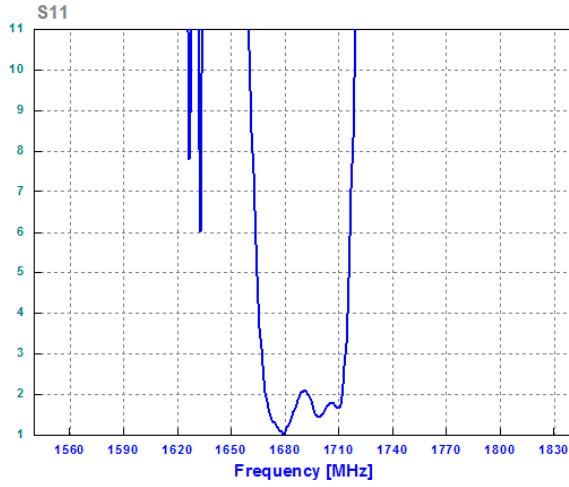

Smith Chart

