



PRODUCT SPECIFICATION

REV A January 2010

Oscilent Controlled Document

Ordering Code / Part Number	Product Description
808-RF751.5M-A	LTE, RX-RF SAW Filter

Specification Contents

- o Mechanical Dimensions
- o Test Circuit
- o Maximum Ratings
- o Electrical Specification
- o Frequency Performance
- o VSWR
- o Smith Chart

Notes

- o Electrostatic Sensitive Device (ESD) 
- o Avoid excessive ultrasonic exposure
- o Solderability compatible with JEDEC J-STD-020C Pb-free process, 260°C peak reflow temperature
- o This product complies with EU directive 2002/95/EC (RoHS compliance)





Mechanical Dimensions (mm)

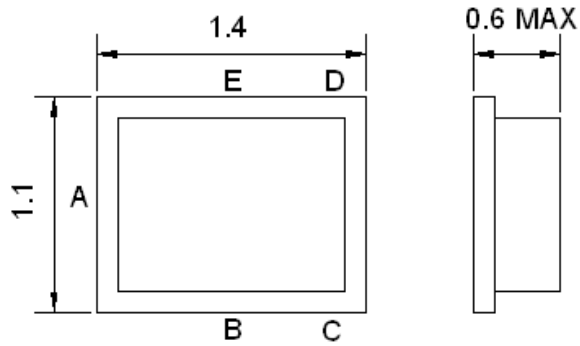

Pin Description	
B, C, E	Ground
A	In
D	Out

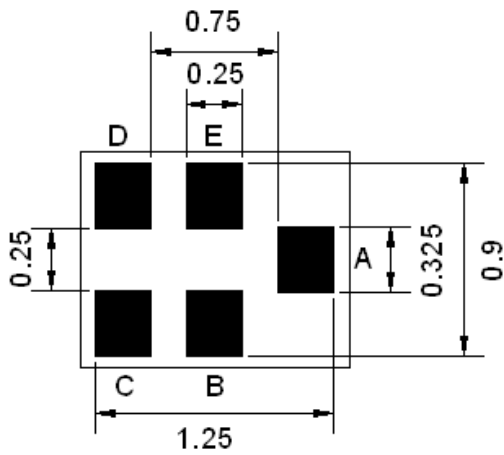

Test Circuit

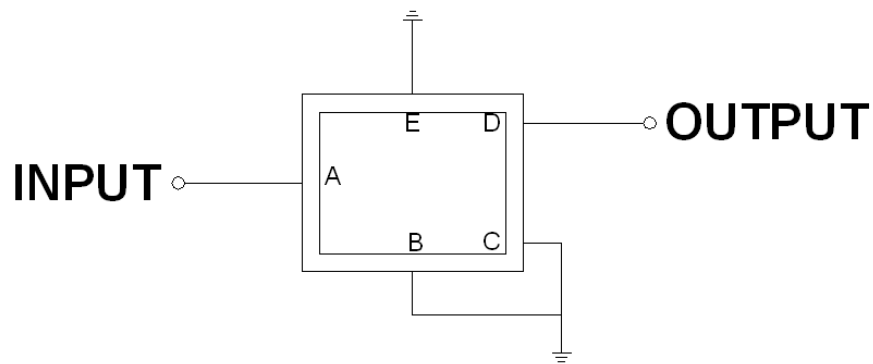

Source and Load Impedance: 50 Ω



Maximum Ratings

Parameters Description	Unit	Minimum	Typical	Maximum
Operating Temperature Range	°C	-30	-	+85
Storage Temperature Range	°C	-40	-	+85
Maximum DC Voltage	V	-	-	0
Maximum Input Power	dBm	-	-	0
Source Impedance (single ended) ⁽¹⁾	Ω	-	50	-
Load Impedance (single ended) ⁽¹⁾	Ω	-	50	-

Notes: (1) No Matching Network (Ref. Testing Environment Circuit as shown above).

(2) Insertion Loss is including PCB Loss. (PCB Loss, 0.2dB)

Electrical Specification

Parameters Description	Unit	Minimum	Typical	Maximum
Center Frequency (Fo)	MHz	-	751.5	-
Insertion Loss within 746.0 ~ 757.0 MHz	dB	-	2.3	3.0
Amplitude Ripple within 746.0~757.0MHz	dB _{p-p}	-	0.7	1.5
Attenuation:				
0.3 ~ 698.0 MHz	dB	40	44	-
698.0 ~ 716.0 MHz	dB	35	42	-
716.0 ~ 728.0 MHz	dB	35	40	-
776.0 ~ 787.0 MHz	dB	33	36	-
788.0 ~ 793.0 MHz	dB	40	50	-
793.0 ~ 805.0 MHz	dB	40	50	-
824.0 ~ 849.0 MHz	dB	40	48	-
1710.0 ~ 1755.0 MHz	dB	25	30	-
1850.0 ~ 1920.0 MHz	dB	25	30	-
VSWR within 746.0~757.0 MHz	-	-	1.5	2.0



Frequency Performance

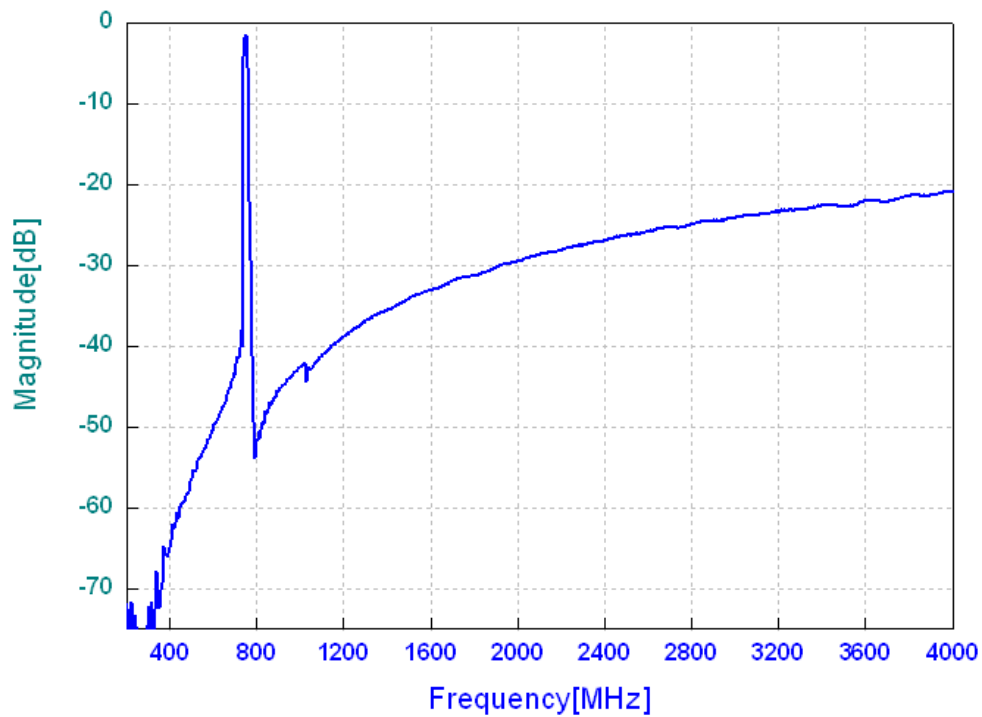
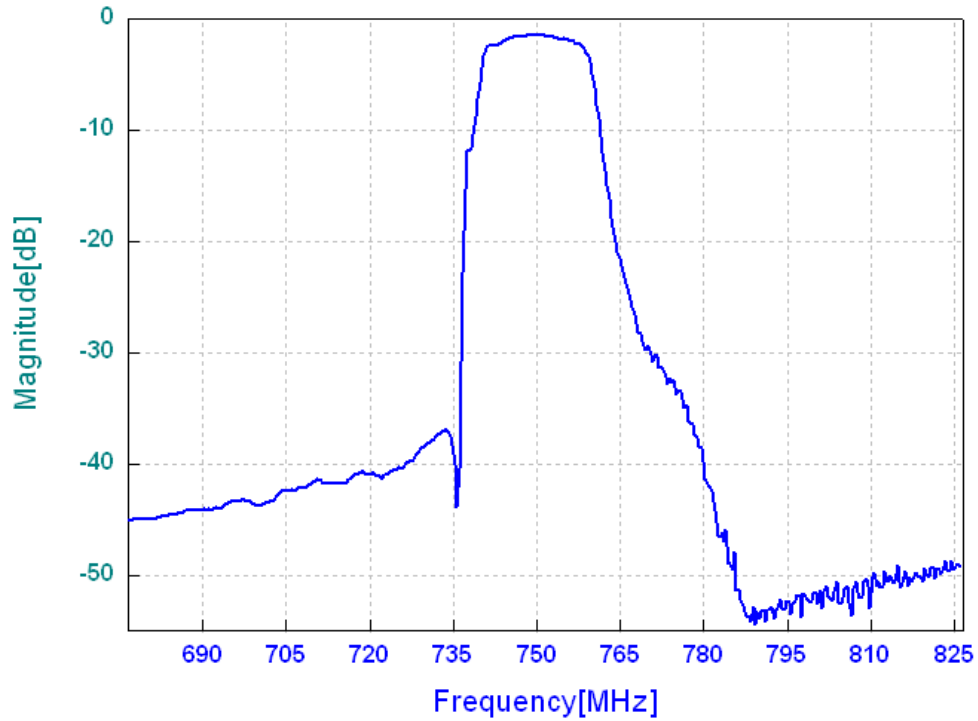



VSWR

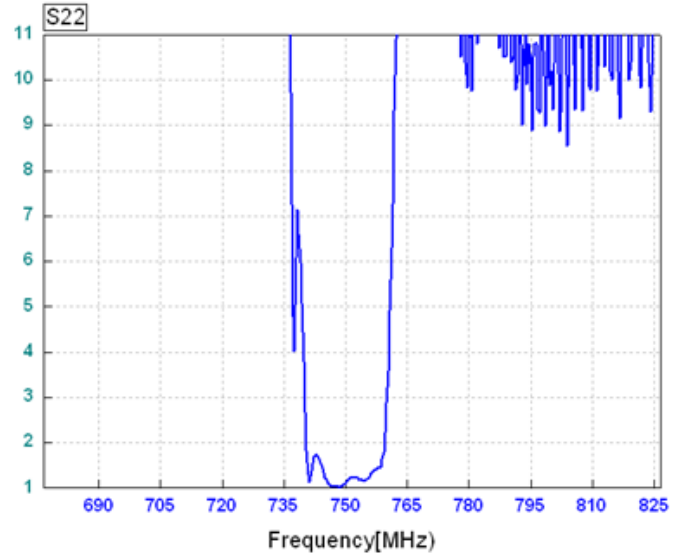
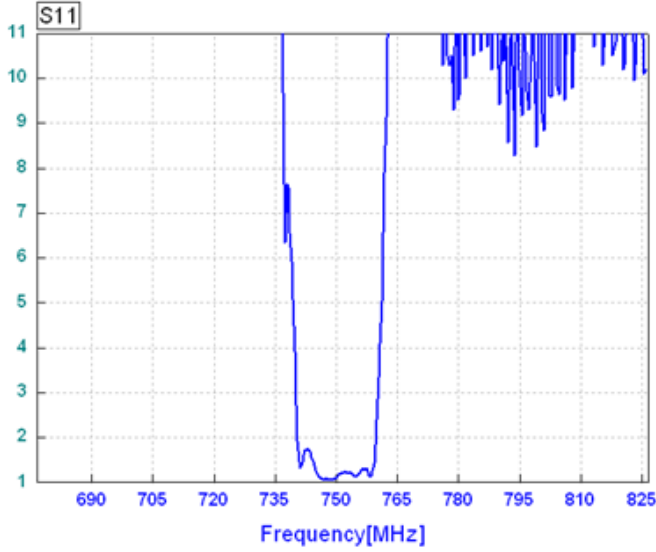

Smith Chart

