



REV A January 2011

Oscilent Controlled Document

Ordering Code / Part Number	Product Description
835-IF62.5M-19A	62.5MHz IF SAW Filter 18.95MHz Bandwidth

Specification Contents

- o Mechanical Dimensions
- o Test Circuit
- o Maximum Ratings
- o Electrical Specification
- o Frequency Response
- o Smith Chart
- o SWR

Notes

- o Electrostatic Sensitive Device (ESD) 
- o Avoid excessive ultrasonic exposure
- o Solderability compatible with JEDEC J-STD-020C Pb-free process, 260°C peak reflow temperature
- o This product complies with EU directive 2002/95/EC (RoHS compliance)





Mechanical Dimensions (mm)

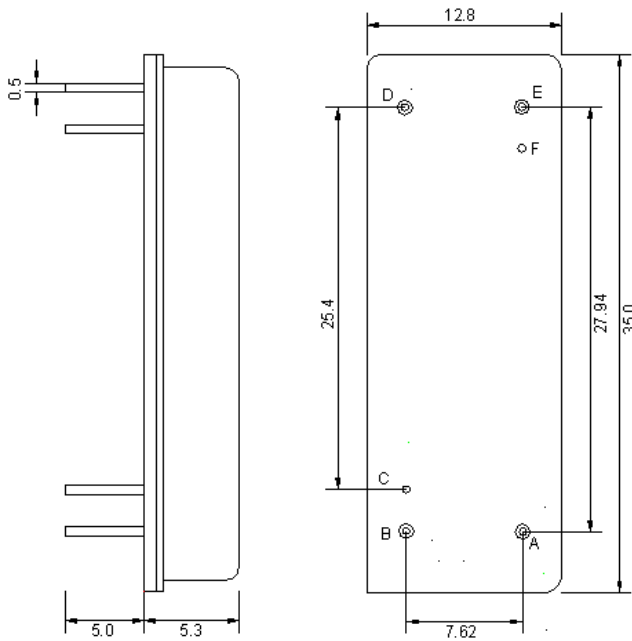

Pin Description	
B, C, D, F	Ground
A	In
E	Out

Test Circuit

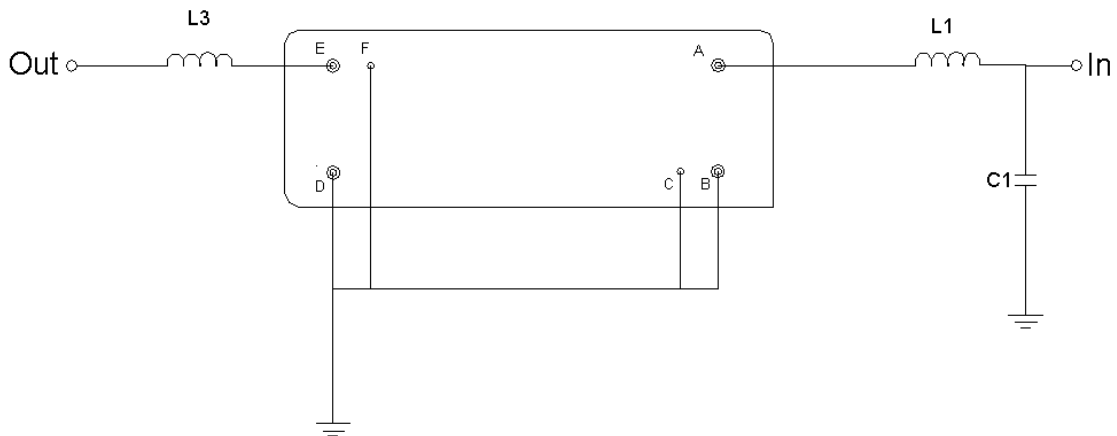

Test Fixture & Values	
Input	L1=220nH, C1=30pF
Output	L2=220nH
Source/Load Impedance	50 Ω



Maximum Ratings

Parameters Description	Unit	Minimum	Typical	Maximum
Operating Temperature Range	°C	-	25	-
Storage Temperature Range	°C	-40	-	85
Maximum DC Voltage	V	-	-	10
Maximum Input Power	dBm	-	-	10
Source Impedance (single ended) ⁽¹⁾	Ω	-	50	-
Load Impedance (single ended) ⁽¹⁾	Ω	-	50	-

Notes: With Matching Network (Ref. Testing Environment Circuit as shown above).

Those impedances could be modified with different impedance values and/or structures, if necessary.

Electrical Specification

Parameters Description	Unit	Minimum	Typical	Maximum
Center Frequency (Fo)	MHz	-	62.5	-
Insertion Loss at Fo	dB	-	23.7	26.0
Temperature Coefficient	ppm/°C	-	-72	-
Amplitude Ripple Variation within fo ±9.22 MHz	dB _{p-p}	-	0.6	1.0
Group Delay Variation within fo ±9.22 MHz	nsec	-	40	90
Absolute Delay at Fo	µsec	-	2.91	-
Bandwidth at -1.0 dB	MHz	18.90	18.95	-
Bandwidth at -3.0 dB	MHz	-	19.17	-
Bandwidth at -40.0 dB	MHz	-	20.15	20.20
Relative Attenuation:				
Fo ±10.0 MHz	dB	25	27	
Lower Sidelobe	dB	50	52	-
Upper Sidelobe	dB	50	52	-



Frequency Response

Bandwidth at -1.0 dB

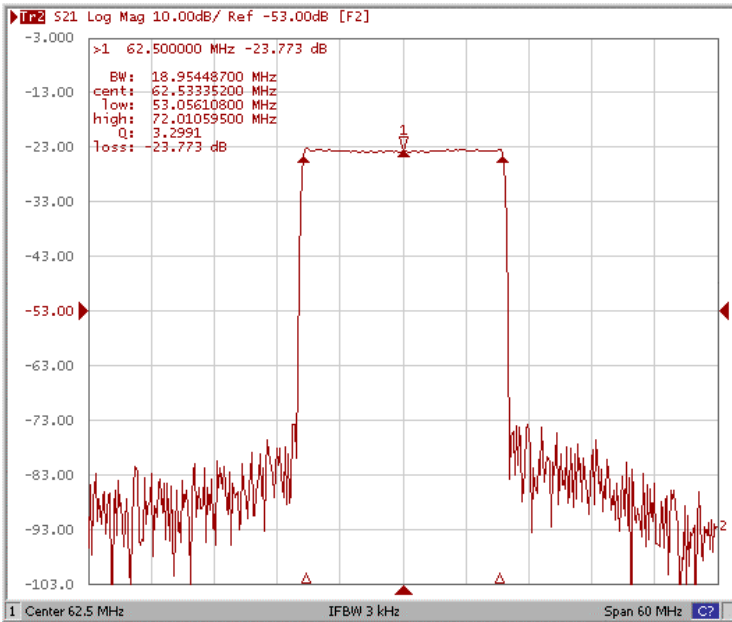

Bandwidth at -3.0 dB

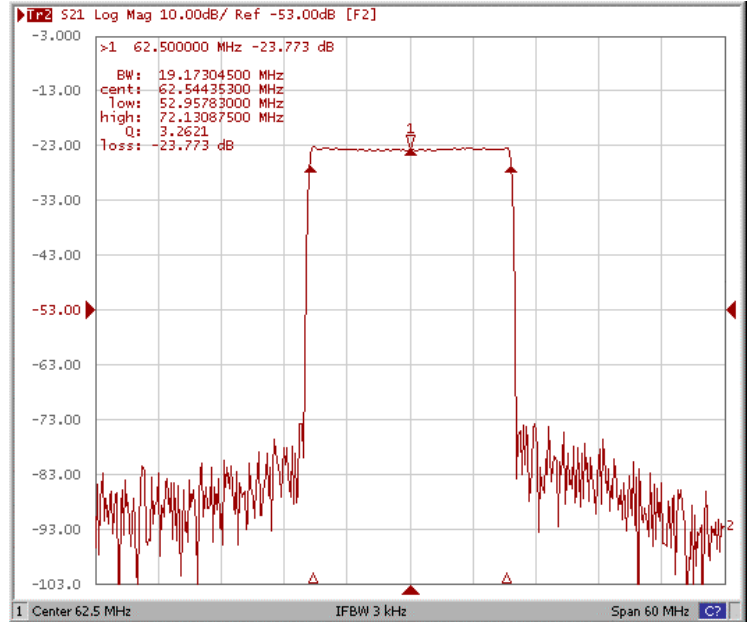

Bandwidth at -40.0 dB

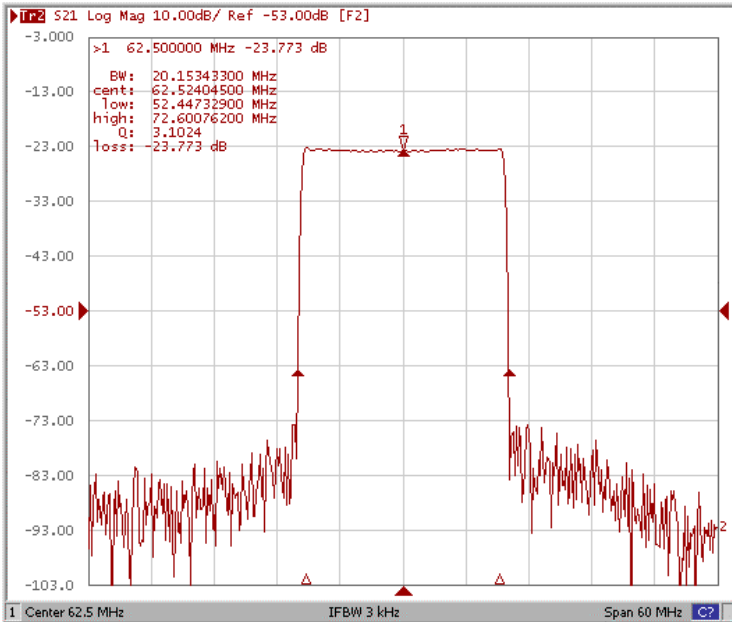

Wide-Band

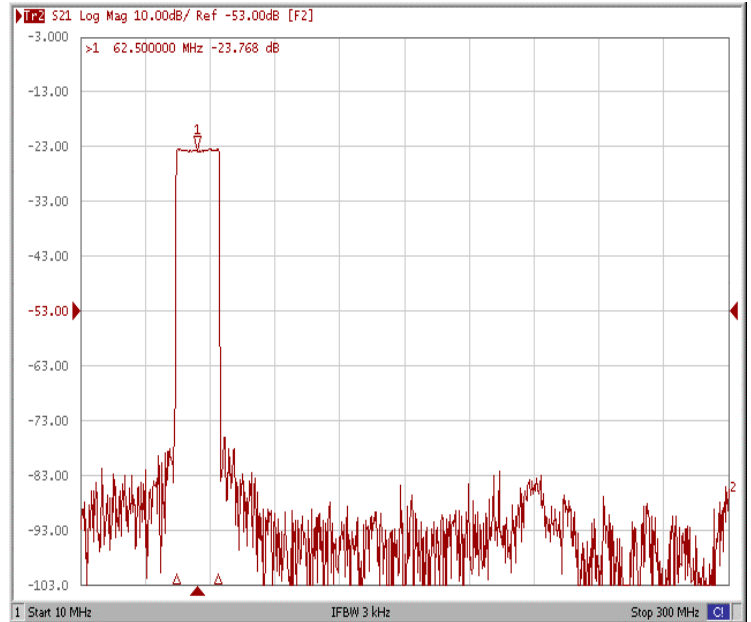



Ripple Variation Fo±9.22MHz

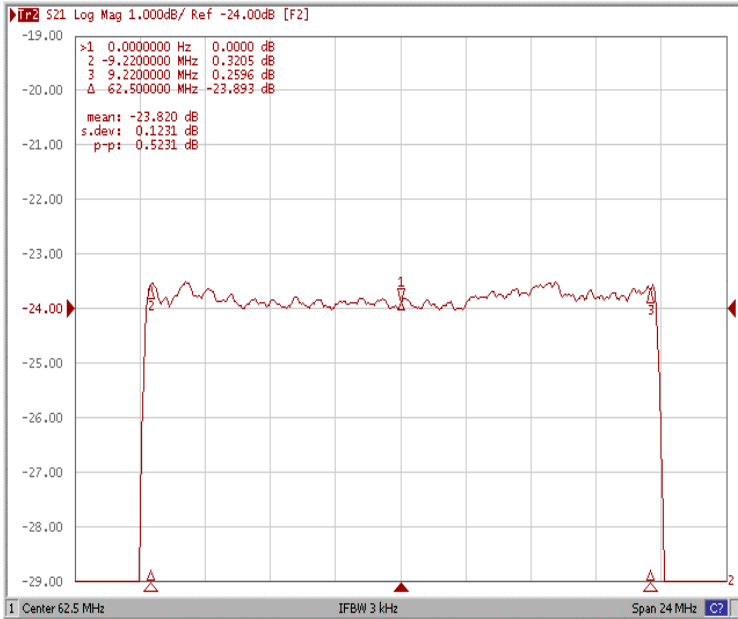

Group Delay Variation Fo±9.22MHz

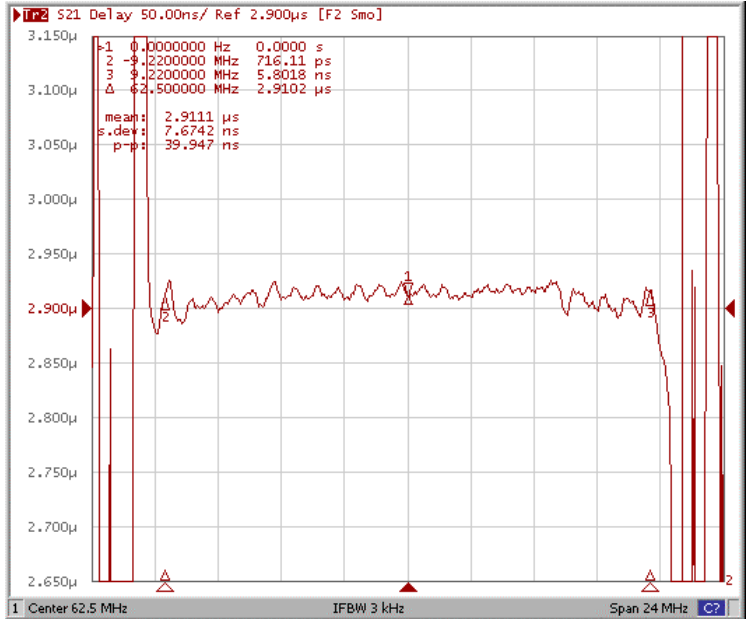

Smith Chart

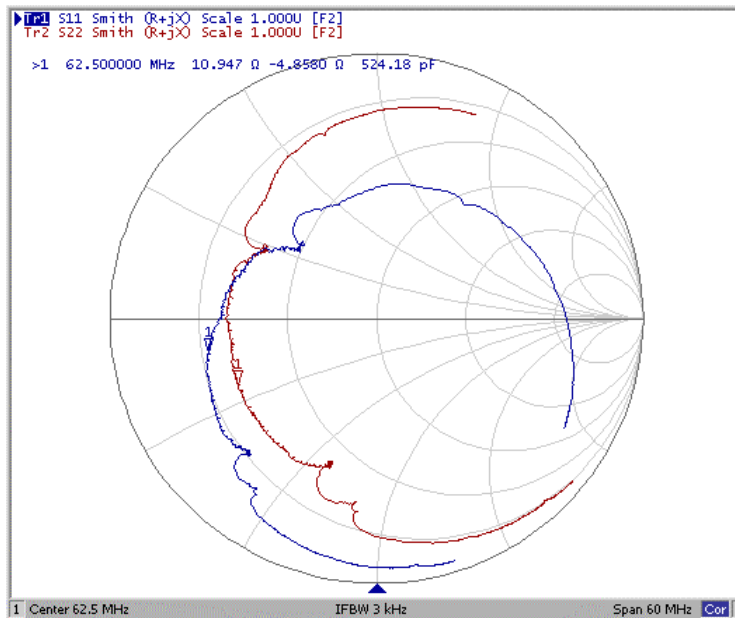



SWR

