



REV A January 2011

Oscilent Controlled Document

Ordering Code / Part Number	Product Description
835-IF60.0M-19A	60.0MHz IF SAW Filter 19.25 MHz Bandwidth

Specification Contents

- o Mechanical Dimensions
- o Test Circuit
- o Maximum Ratings
- o Electrical Specification
- o Frequency Response
- o Smith Chart
- o VSWR

Notes

- o Electrostatic Sensitive Device (ESD) 
- o Avoid excessive ultrasonic exposure
- o Solderability compatible with JEDEC J-STD-020C Pb-free process, 260°C peak reflow temperature
- o This product complies with EU directive 2002/95/EC (RoHS compliance)





Mechanical Dimensions (mm)

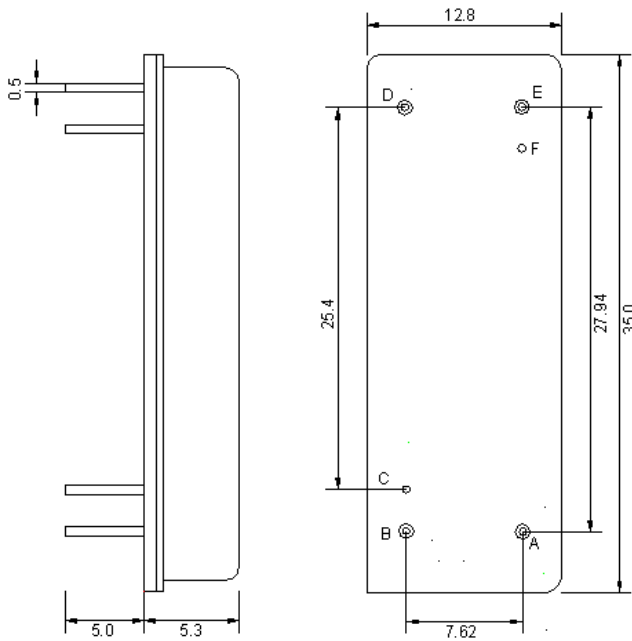

Pin Description	
B, C, D, F	Ground
A	In
E	Out

Test Circuit

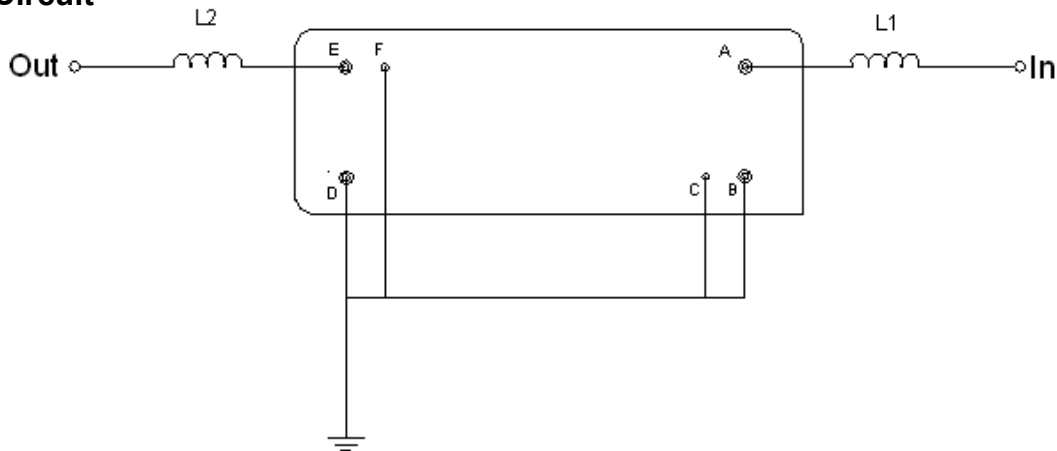

Test Fixture & Values	
Input	L1=270 nH
Output	L2=150 nH
Source/Load Impedance	50 Ω



Maximum Ratings

Parameters Description	Unit	Minimum	Typical	Maximum
Operating Temperature Range	°C	-20	-	70
Storage Temperature Range	°C	-40	-	85
Maximum DC Voltage	V	-	-	10
Maximum Input Power	dBm	-	-	10
Source Impedance (single ended) ⁽¹⁾	Ω	-	50	-
Load Impedance (single ended) ⁽¹⁾	Ω	-	50	-

Notes: With Matching Network (Ref. Testing Environment Circuit as shown above).

Those impedances could be modified with different impedance values and/or structures, if necessary.

Electrical Specification

Parameters Description	Unit	Minimum	Typical	Maximum
Center Frequency (Fo)	MHz	59.90	60.0	60.10
Insertion Loss at Fo	dB	-	25.2	27.0
Group Delay Variation (Fo±9.22MHz)	ns	-	35	80
Absolute Delay Time at Fo	us	-	2.46	-
Temperature Coefficient	ppm/°C	-	-72	-
Amplitude Ripple (Fo±9.22MHz)	dB	-	0.52	0.95
Bandwidth at -1dB	MHz	-	19.25	-
Bandwidth at -3dB	MHz	19.40	19.54	-
Bandwidth at -30dB	MHz	-	20.61	-
Bandwidth at -40dB	MHz	-	20.78	21.00
Ultimate Rejection	dB	50	55	-



Frequency Response

Bandwidth at -1.0 dB

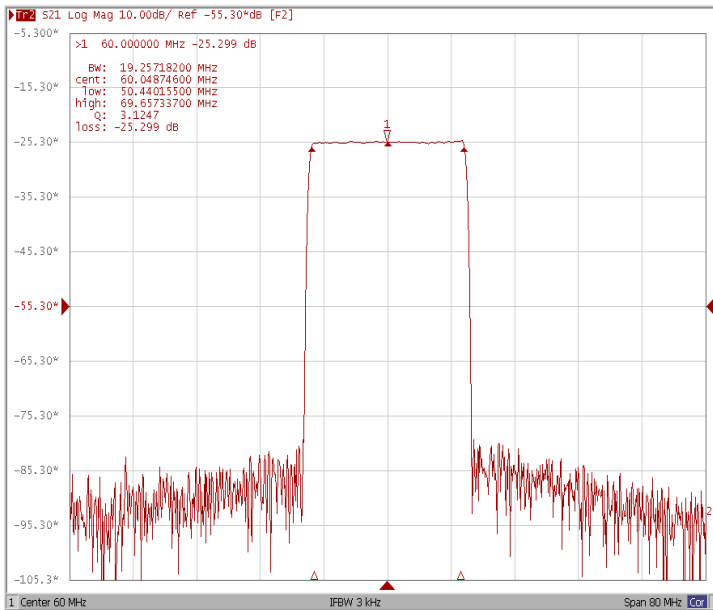

Bandwidth at -3.0 dB

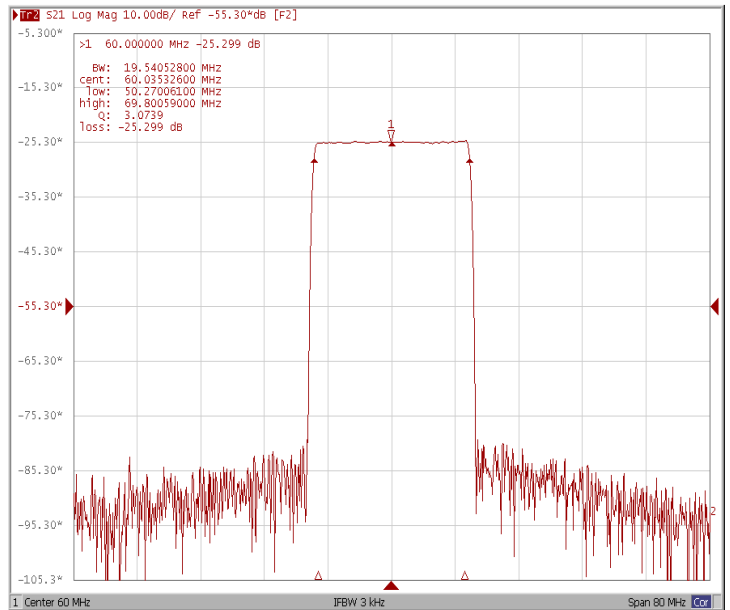

Bandwidth at -30.0 dB

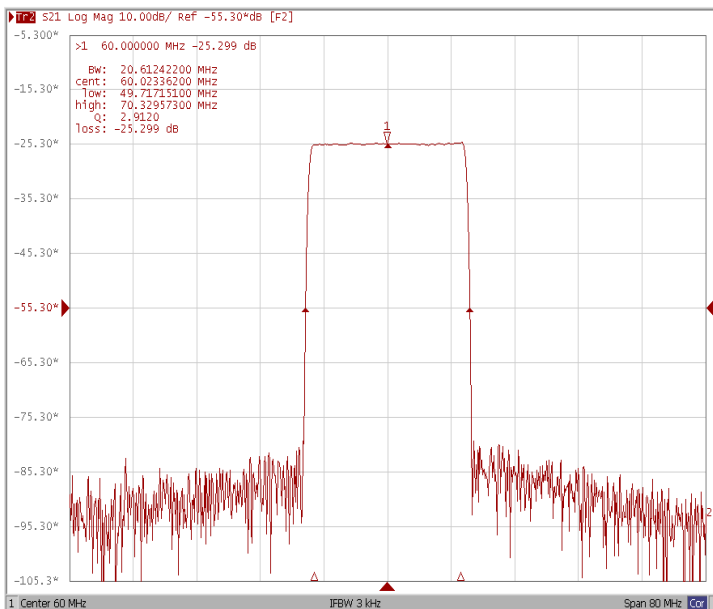

Bandwidth at -40.0 dB

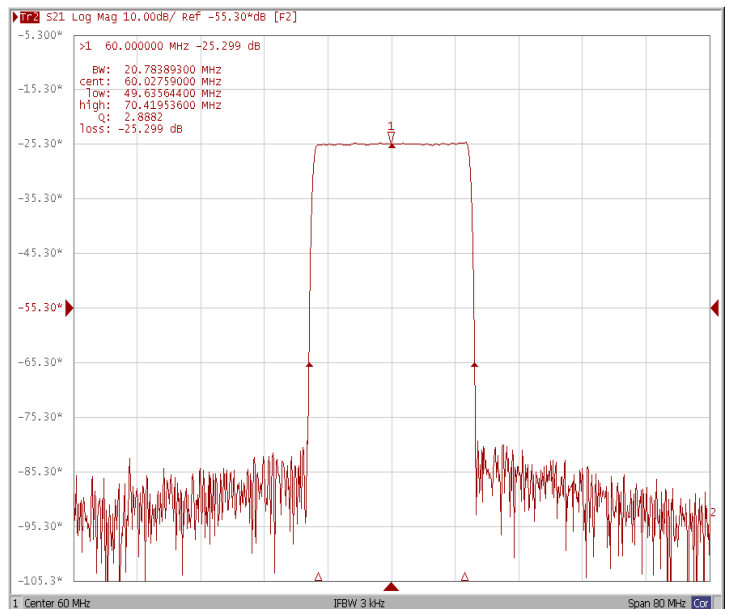



Ripple Variation $F_o \pm 9.22\text{MHz}$

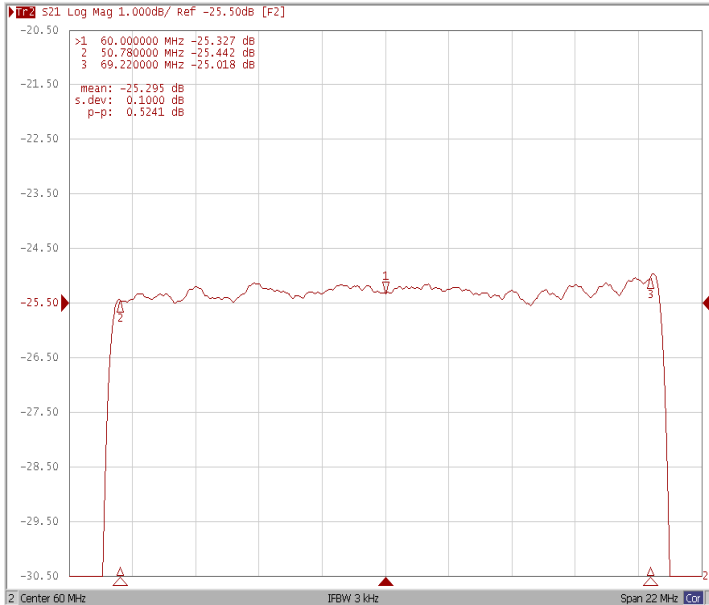

Group Delay Variation $F_o \pm 9.22\text{MHz}$

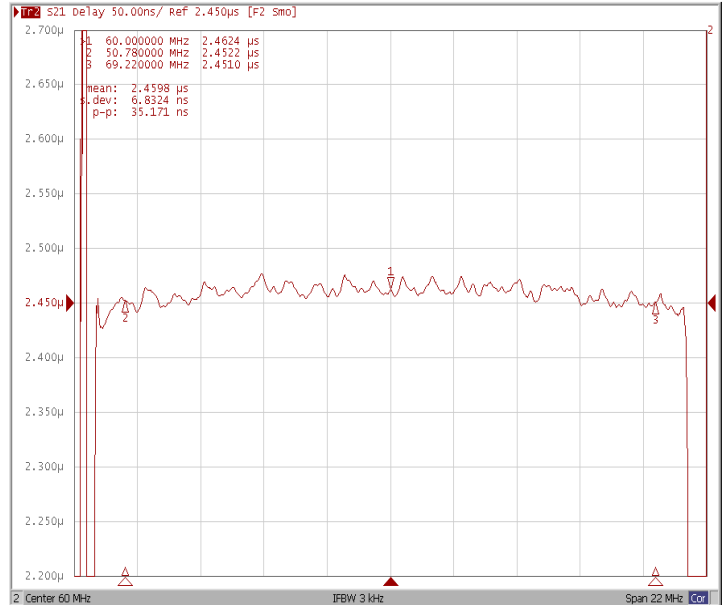

Smith Chart

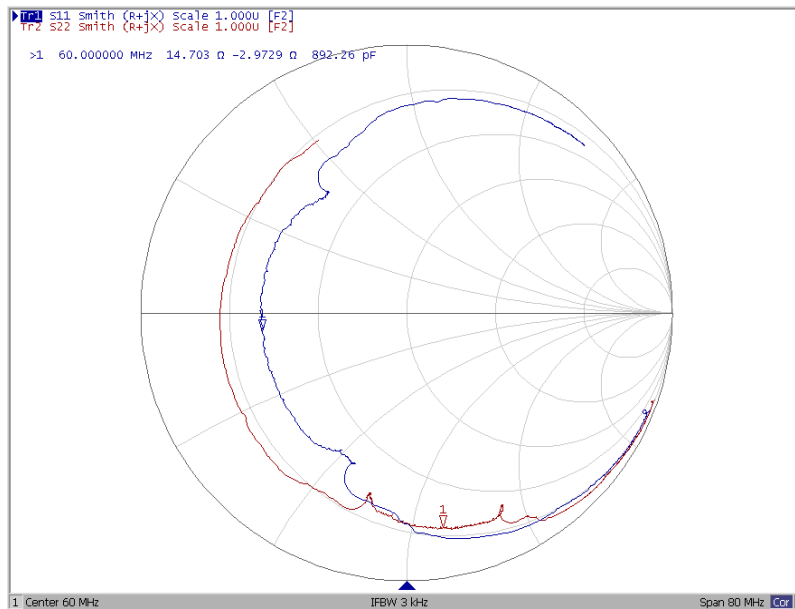



VSWR

