



REV A January 2011

Oscilent Controlled Document

Ordering Code / Part Number	Product Description
835-IF160.0M-09C	160.0MHz IF SAW Filter 9.79 MHz Bandwidth

Specification Contents

- o Mechanical Dimensions
- o Test Circuit
- o Maximum Ratings
- o Electrical Specification
- o Frequency Response
- o Smith Chart
- o VSWR

Notes

- o Electrostatic Sensitive Device (ESD) 
- o Avoid excessive ultrasonic exposure
- o Solderability compatible with JEDEC J-STD-020C Pb-free process, 260°C peak reflow temperature
- o This product complies with EU directive 2002/95/EC (RoHS compliance)





Mechanical Dimensions (mm)

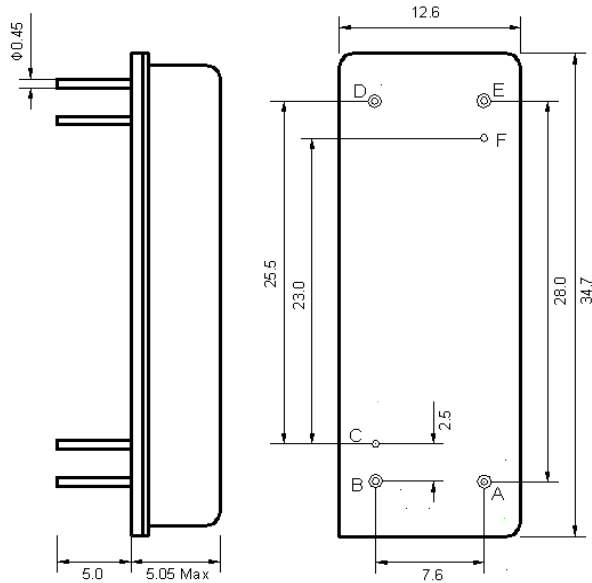

Pin Description	
B, C, D, F	Ground
A	Input
E	Output

Test Circuit

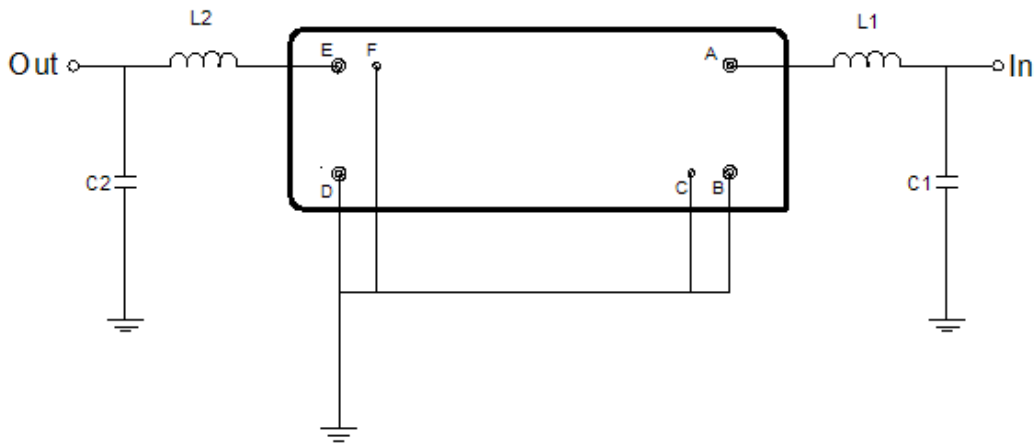

Test Fixture & Values	
Input	L1=27 nH, C1=47 pF
Output	L2=33 nH, C2=43 pF
Source/Load Impedance	50 Ω



Maximum Ratings

Parameters Description	Unit	Minimum	Typical	Maximum
Operating Temperature Range	°C	-20	-	70
Storage Temperature Range	°C	-20	-	70
Maximum DC Voltage	V	-	-	10
Maximum Input Power	dBm	-	-	10
Source Impedance (single ended) ⁽¹⁾	Ω	-	50	-
Load Impedance (single ended) ⁽¹⁾	Ω	-	50	-

Notes: With Matching Network (Ref. Testing Environment Circuit as shown above).

Those impedances could be modified with different impedance values and/or structures, if necessary.

Electrical Specification

Parameters Description	Unit	Minimum	Typical	Maximum
Center Frequency (Fo)	MHz	-	160.0	-
Insertion Loss at Fo	dB	-	24.5	26.0
Group Delay Variation (Fo±4.59MHz)	ns	-	62	100
Phase Linearity (Fo±4.59MHz)	deg		11.7	13.0
Absolute Delay Time at Fo	us	-	3.84	4.00
Temperature Coefficient	ppm/°C	-	-20	-
Amplitude Ripple (Fo±4.59MHz)	dB	-	0.76	1.00
Bandwidth at -1dB	MHz	9.65	9.79	-
Bandwidth at -45dB	MHz	-	11.03	11.25
Input & Output Return Loss	dB	6	8	-
Triple transit attenuation	dBc	35	-	-
Relative Attenuation				
10MHz~150.0MHz	dBc	40	64	-
@154.84 MHz	dBc	2	7.8	-
@154.94 MHz	dBc	2	4.1	-
@165.06 MHz	dBc	2	4.0	-
@165.16 MHz	dBc	7	7.7	-
170.0MHz ~300.0MHz	dBc	40	64	-



Frequency Response

Bandwidth at -1.0 dB

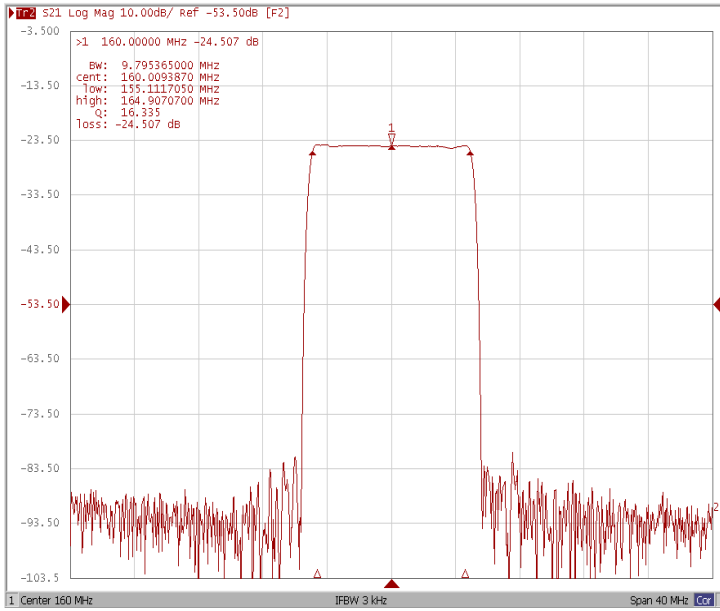

Bandwidth at -3.0 dB

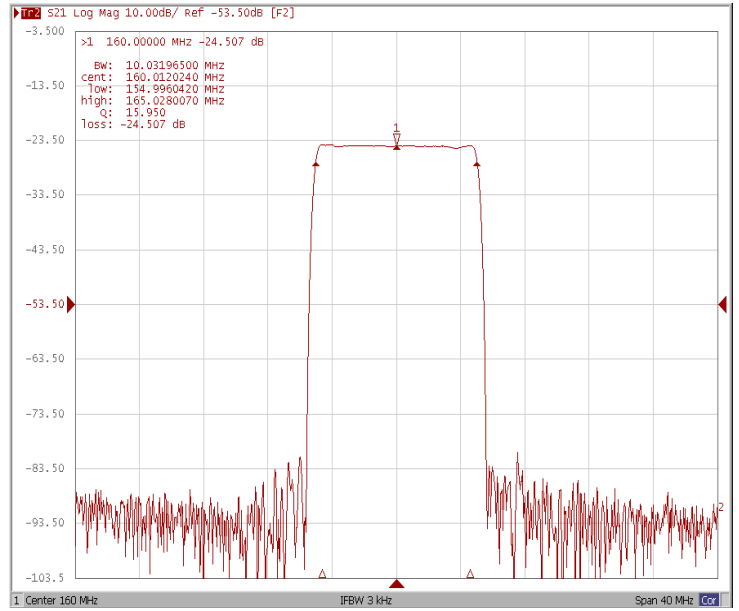

Bandwidth at -45.0 dB

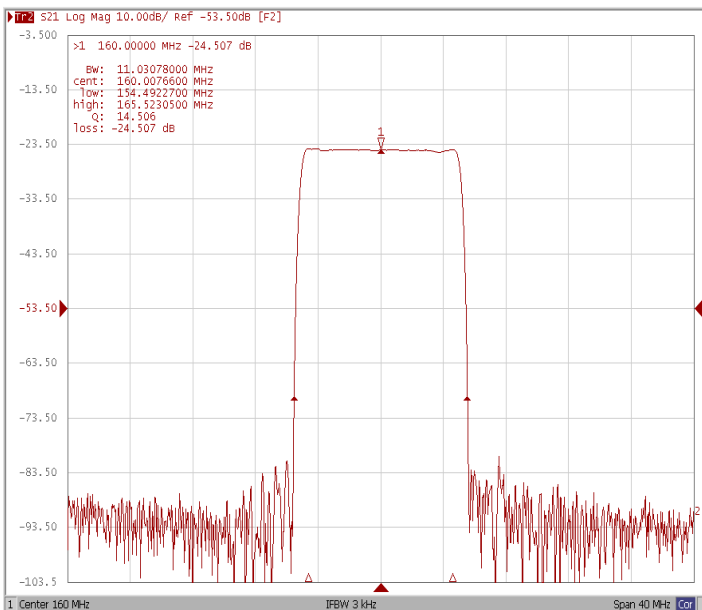

Relative Attenuation

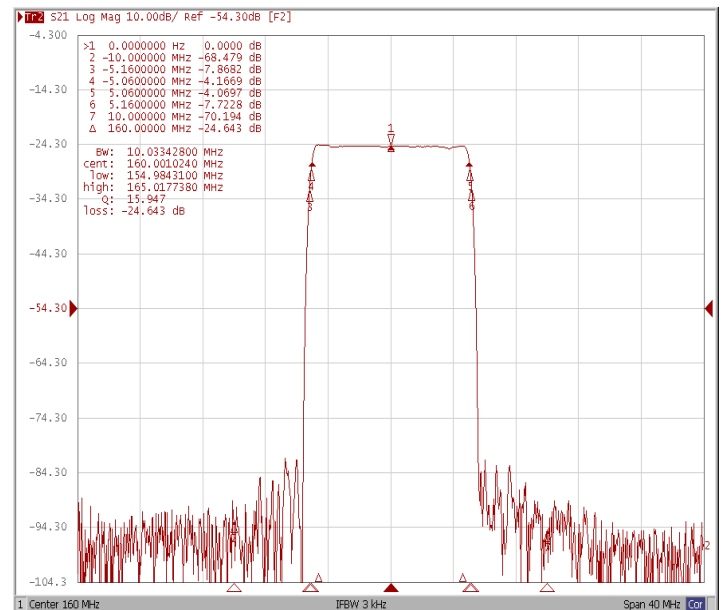



Ripple Variation Fo±4.59MHz

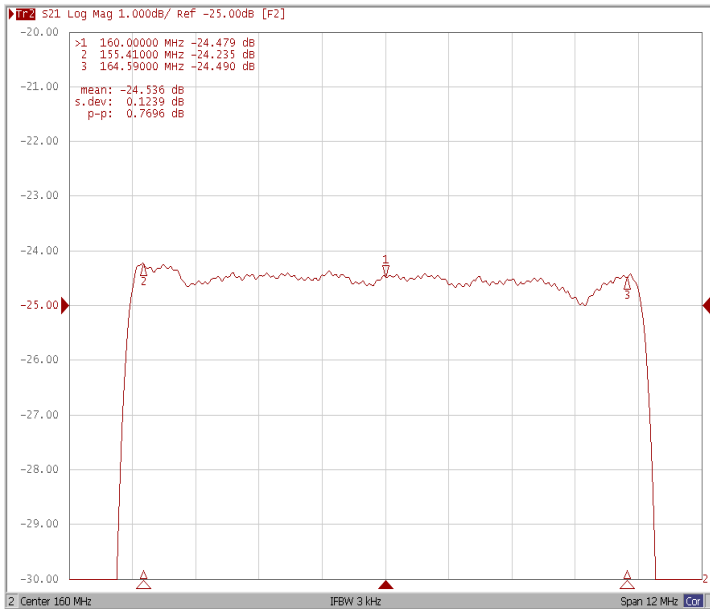

Group Delay Variation Fo±4.59MHz

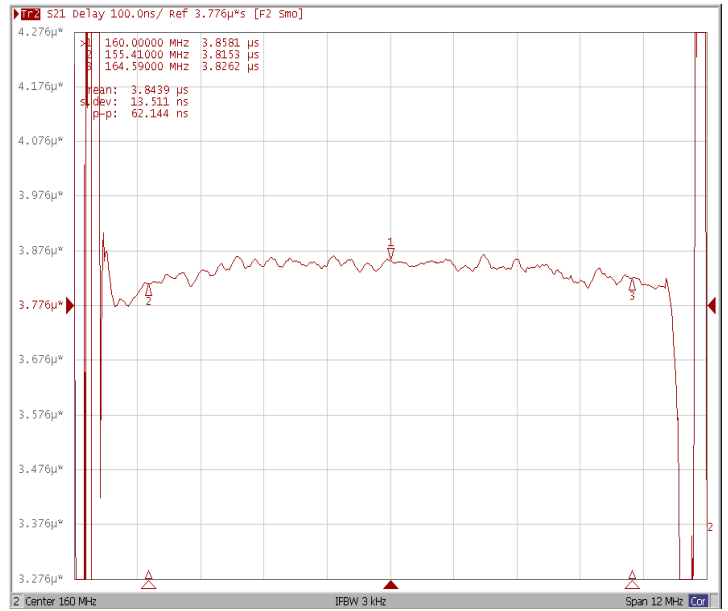

Phase Linearity Fo±4.59MHz

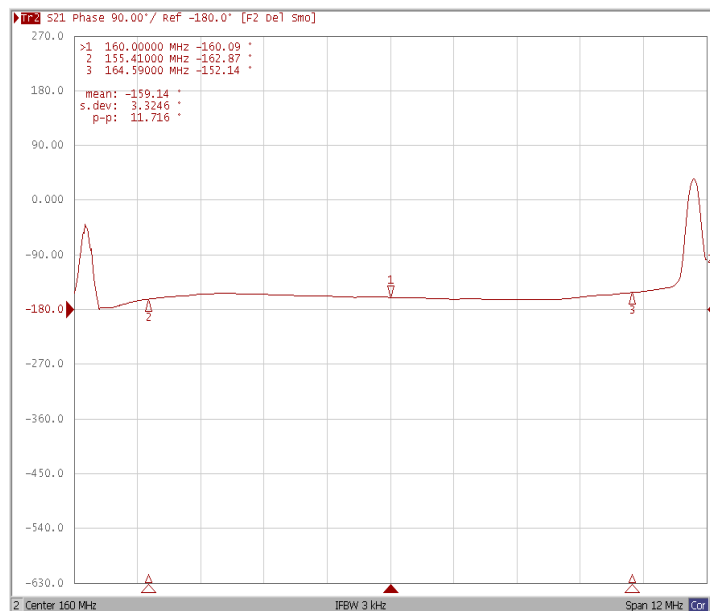



Return Loss S11



Return Loss S22

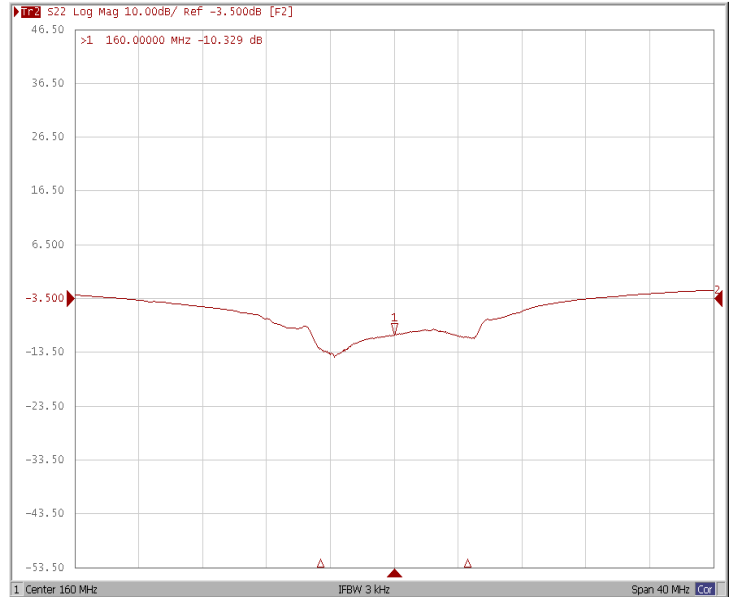

Smith Chart

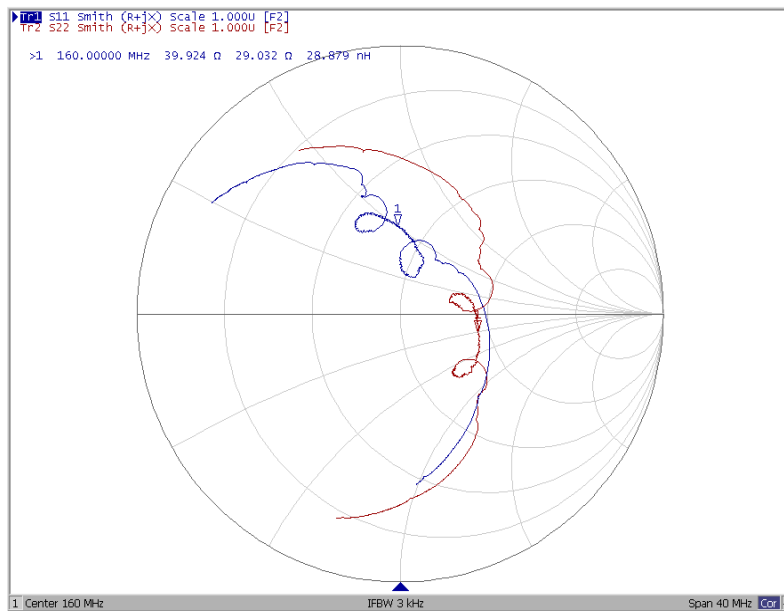



VSWR

S11



S22

