



REV A January 2011

Oscilent Controlled Document

Ordering Code / Part Number	Product Description
835-IF145.0M-D	145.00MHz IF SAW Filter 9.24 MHz Bandwidth

Specification Contents

- o Mechanical Dimensions
- o Test Circuit
- o Maximum Ratings
- o Electrical Specification
- o Frequency Response
- o Smith Chart
- o VSWR

Notes

- o Electrostatic Sensitive Device (ESD) 
- o Avoid excessive ultrasonic exposure
- o Solderability compatible with JEDEC J-STD-020C Pb-free process, 260°C peak reflow temperature
- o This product complies with EU directive 2002/95/EC (RoHS compliance)





Mechanical Dimensions (mm)

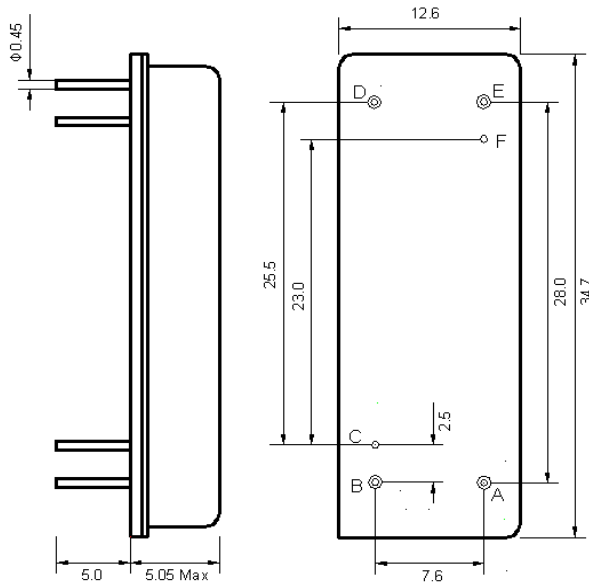

Pin Description	
B, C, D, F	Ground
A	In
E	Out

Test Circuit

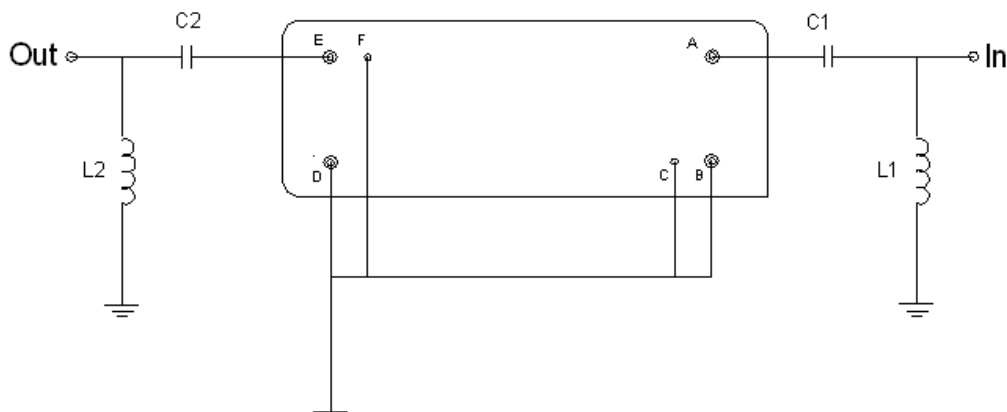

Test Fixture & Values	
Input	L1=27 nH, C1=82 pF
Output	L2=22 nH, C2=82 pF
Source/Load Impedance	50 Ω



Maximum Ratings

Parameters Description	Unit	Minimum	Typical	Maximum
Operating Temperature Range	°C	-20	-	70
Storage Temperature Range	°C	-40	-	85
Maximum DC Voltage	V	-	-	10
Maximum Input Power	dBm	-	-	10
Source Impedance (single ended) ⁽¹⁾	Ω	-	50	-
Load Impedance (single ended) ⁽¹⁾	Ω	-	50	-

Notes: With Matching Network (Ref. Testing Environment Circuit as shown above).
Those impedances could be modified with different impedance values and/or structures, if necessary.

Electrical Specification

Parameters Description	Unit	Minimum	Typical	Maximum
Center Frequency (Fo)	MHz	-	145.0	-
Insertion Loss at Fo	dB	-	25.6	27.5
Group Delay Variation (Fo±4.52MHz)	ns	-	97	150
Absolute Delay Time at Fo	us	-	4.27	-
Temperature Coefficient	ppm/°C	-	-18	-
Amplitude Ripple (Fo±4.52MHz)	dB	-	0.66	1.00
Bandwidth at -1dB	MHz	9.04	9.25	-
Bandwidth at -3dB	MHz	-	9.44	-
Bandwidth at -50dB	MHz	-	10.28	-
Relative Attenuation				
Fo ± 5.1MHz~ Fo ± 5.9MHz	dBc	24	38	-
Fo ± 5.9MHz~ Fo ± 9.9MHz	dBc	39	48	-
Fo ± 9.9MHz~ Fo ± 14.9MHz	dBc	39	50	-
Fo ± 14.9MHz~ Fo ± 20.0MHz	dBc	49	60	-
Ultimate Rejection	dB	-	50	-



Frequency Response

Bandwidth at -1.0 dB

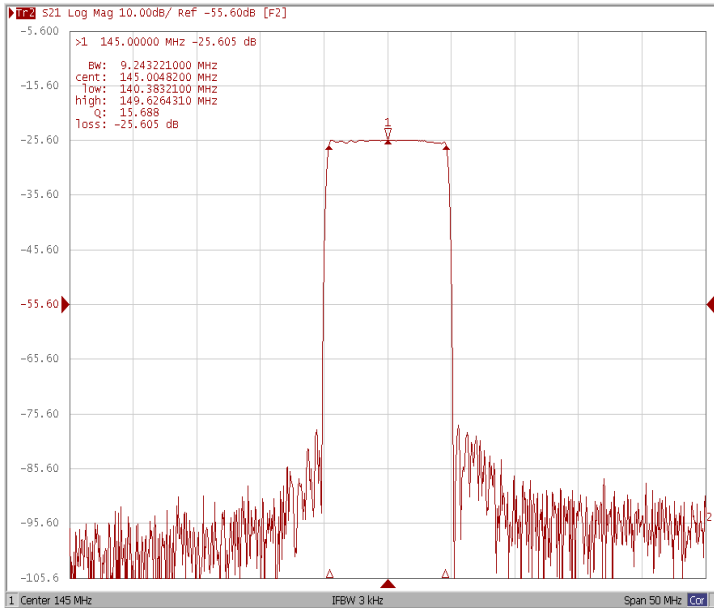

Bandwidth at -3.0 dB

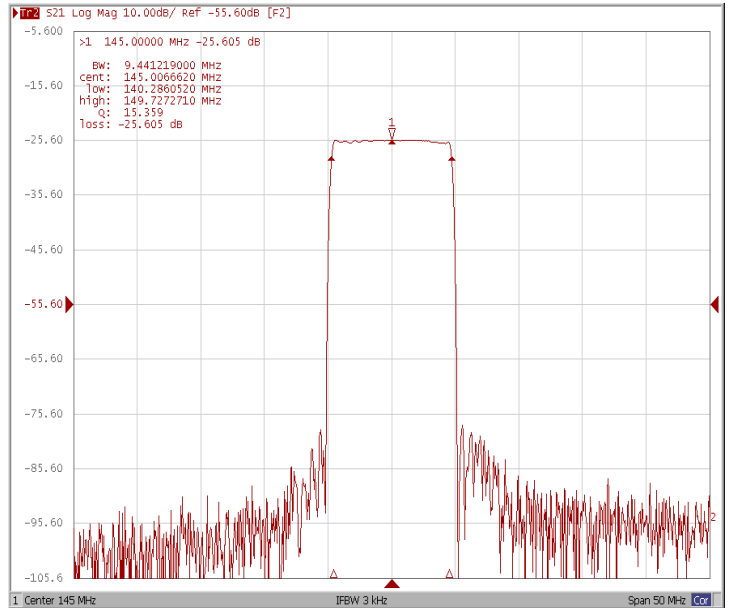

Bandwidth at -50.0 dB

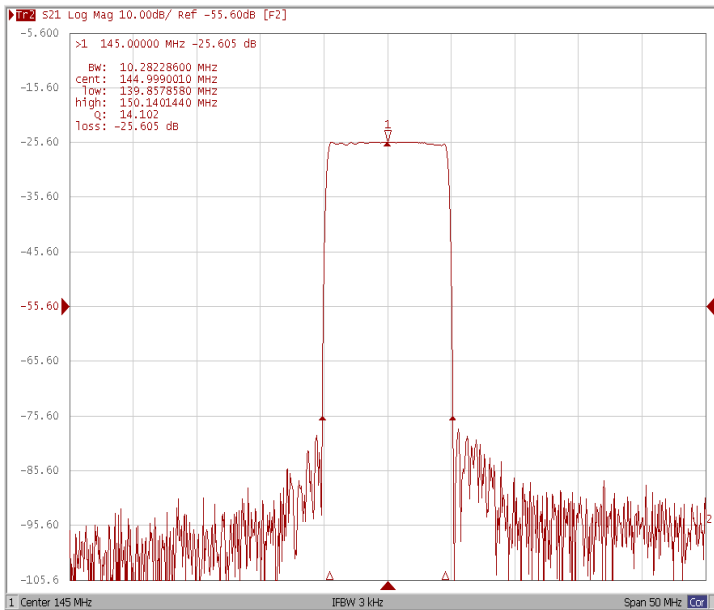

Relative Attenuation

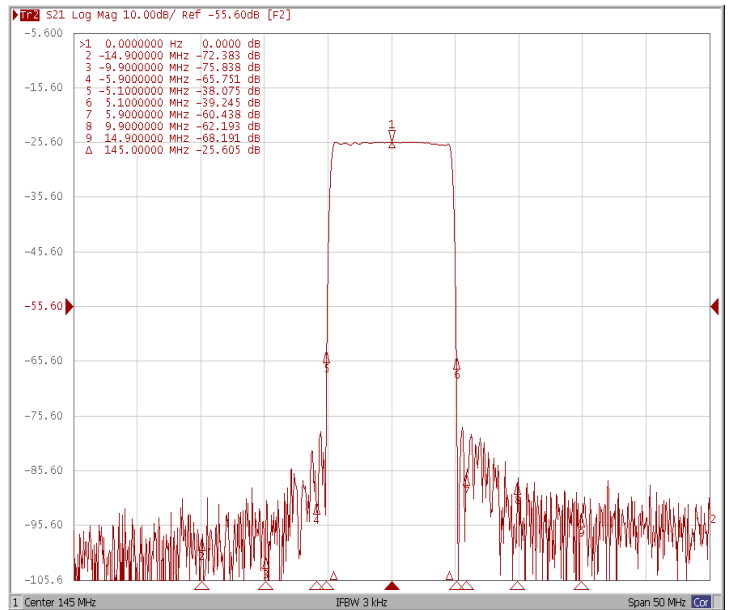



Ripple Variation Fo±4.52MHz

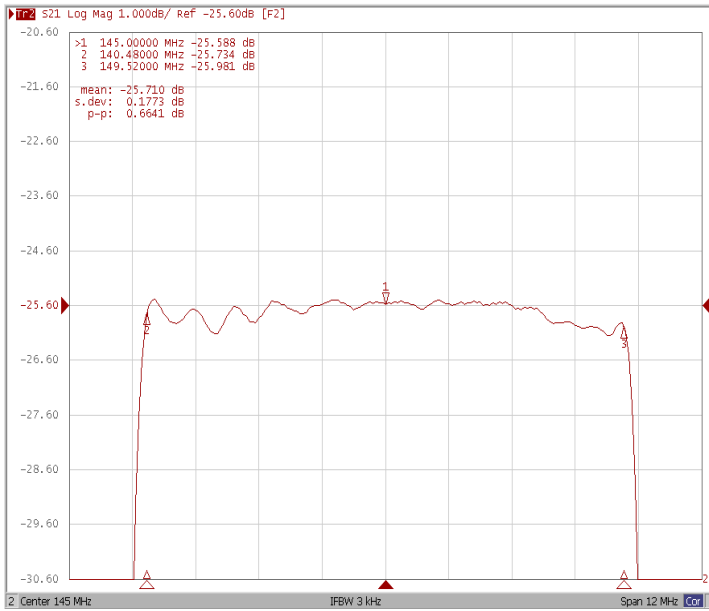

Group Delay Variation Fo±4.52MHz

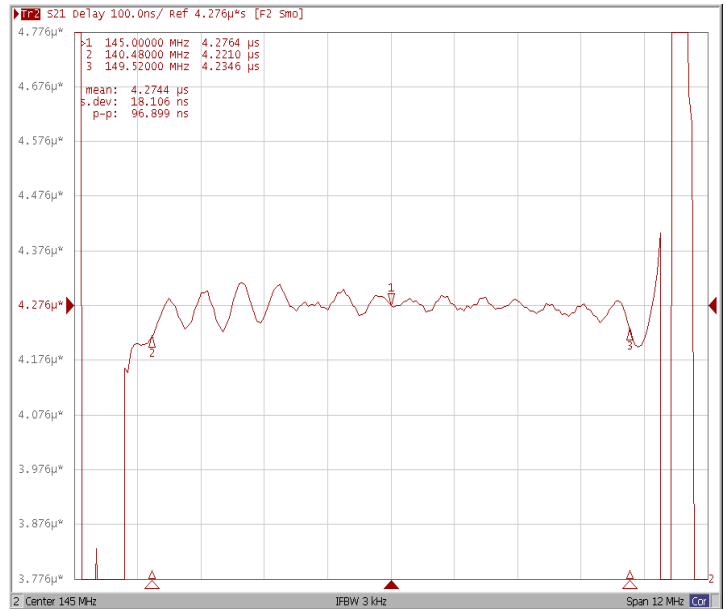

Smith Chart

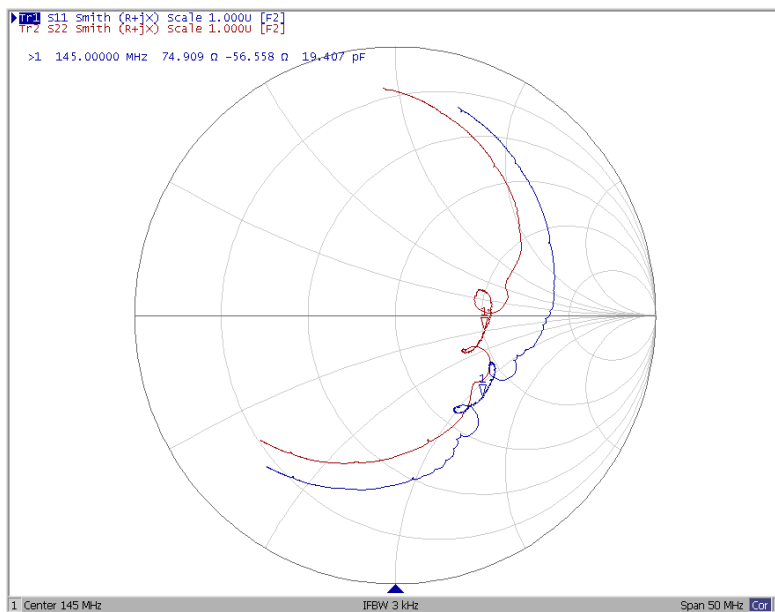



VSWR

