



# PRODUCT SPECIFICATION

REV A January 2011

Oscilent Controlled Document

Ordering Code / Part Number	Product Description
835-IF125.0M-30D	25.00MHz IF SAW Filter 29.16 MHz Bandwidth

## Specification Contents

- o Mechanical Dimensions
- o Test Circuit
- o Maximum Ratings
- o Electrical Specification
- o Frequency Response
- o Smith Chart
- o VSWR

## Notes

- o Electrostatic Sensitive Device (ESD) 
- o Avoid excessive ultrasonic exposure
- o Solderability compatible with JEDEC J-STD-020C Pb-free process, 260°C peak reflow temperature
- o This product complies with EU directive 2002/95/EC (RoHS compliance)





## Mechanical Dimensions (mm)

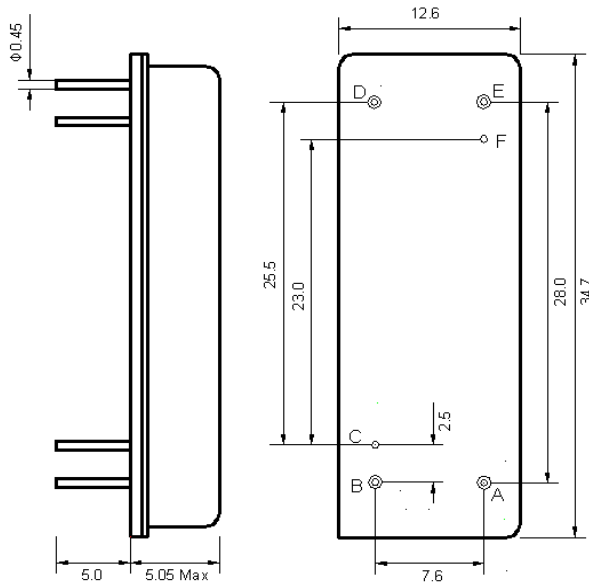

Pin Description	
B, C, D, F	Ground
A	In
E	Out

## Test Circuit

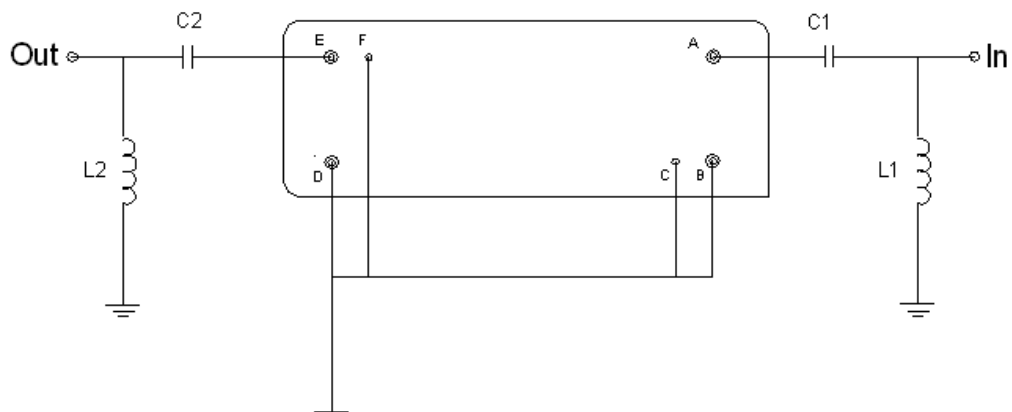

Test Fixture & Values	
Input	L1=56 nH, C1=100 pF
Output	L2=56 nH, C2=100 pF
Source/Load Impedance	50 Ω



## Maximum Ratings

Parameters Description	Unit	Minimum	Typical	Maximum
Operating Temperature Range	°C	-20	-	70
Storage Temperature Range	°C	-40	-	85
Maximum DC Voltage	V	-	-	10
Maximum Input Power	dBm	-	-	10
Source Impedance (single ended) <sup>(1)</sup>	Ω	-	50	-
Load Impedance (single ended) <sup>(1)</sup>	Ω	-	50	-

Notes: With Matching Network (Ref. Testing Environment Circuit as shown above).

Those impedances could be modified with different impedance values and/or structures, if necessary.

## Electrical Specification

Parameters Description	Unit	Minimum	Typical	Maximum
Center Frequency (Fo)	MHz	-	125.00	-
Insertion Loss at Fo	dB	-	28.5	30.5
Group Delay Variation (Fo±14.52MHz)	ns	-	45	80
Absolute Delay Time at Fo	us	-	3.1	-
Temperature Coefficient	ppm/°C	-	-72	-
Amplitude Ripple (Fo±14.52MHz)	dB	-	0.75	-
Bandwidth at -1dB	MHz	29.05	29.16	-
Bandwidth at -3dB	MHz	-	29.36	-
Bandwidth at -40dB	MHz	-	30.25	30.35
Relative Attenuation				
Fo ±15.1MHz~ Fo ± 15.9MHz	dBc	24	35	-
Fo ± 15.9MHz~ Fo ± 19.9MHz	dBc	39	50	-
Fo ± 19.9MHz~ Fo ± 24.9MHz	dBc	39	50	-
Fo ± 24.9MHz~ Fo ± 30.0MHz	dBc	49	53	-
Ultimate Rejection	dB	-	50	-



### Frequency Response

#### Bandwidth at -1.0 dB

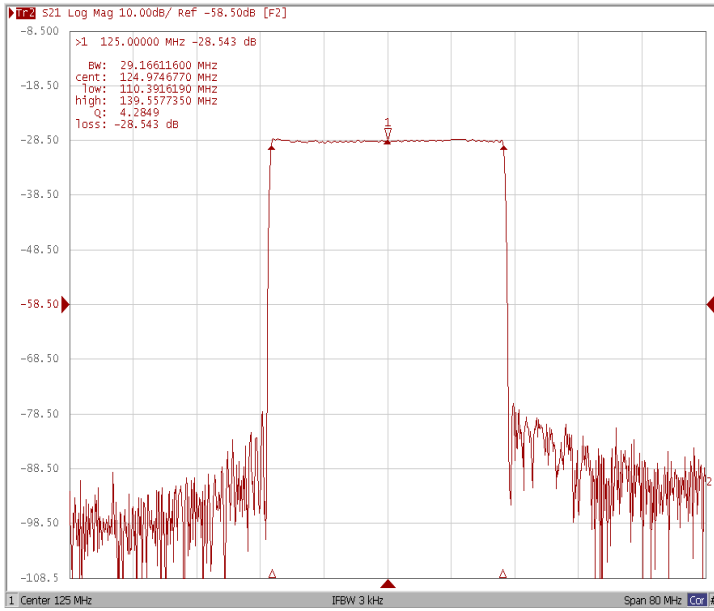

#### Bandwidth at -3.0 dB

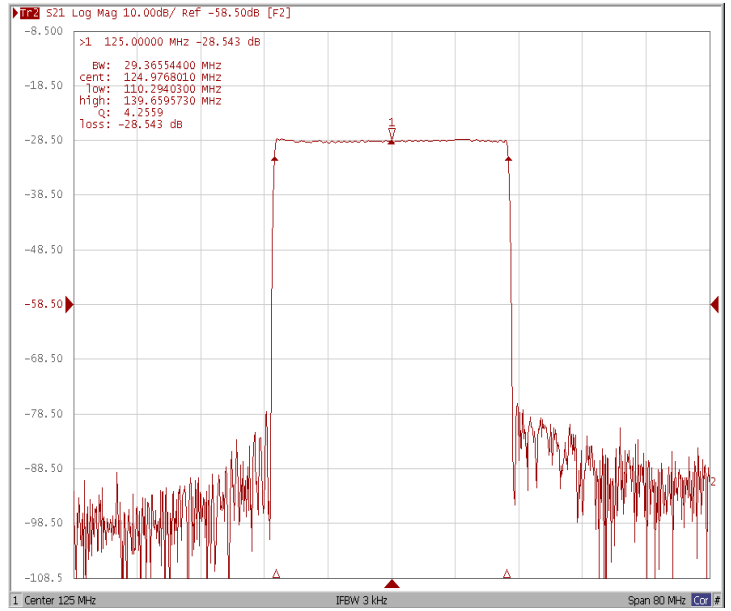

#### Bandwidth at -40.0 dB

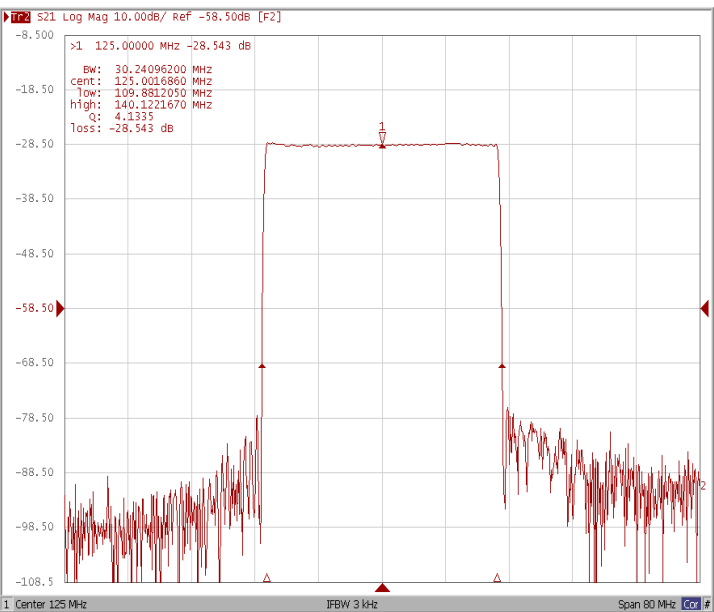

#### Relative Attenuation

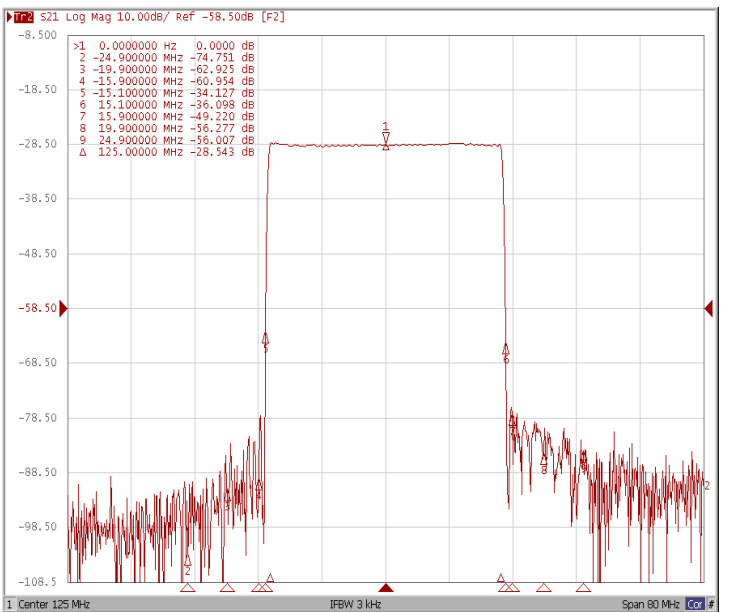



### Ripple Variation $F_o \pm 14.52\text{MHz}$

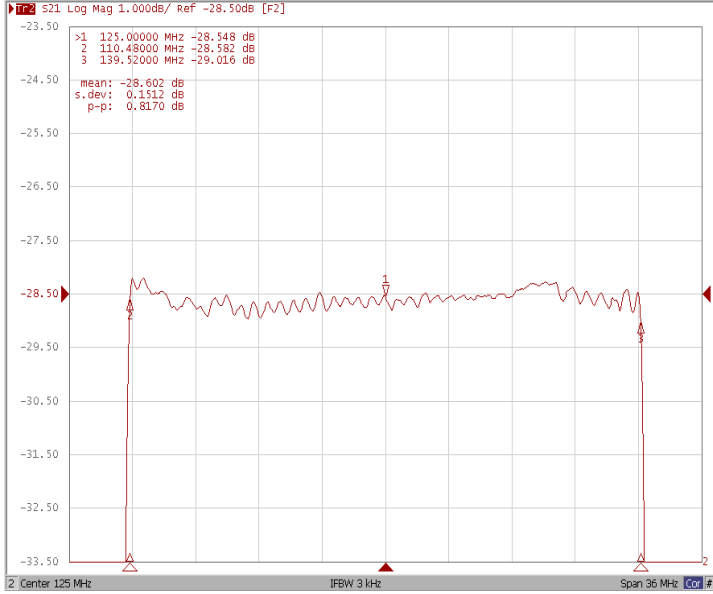

### Group Delay Variation $F_o \pm 14.52\text{MHz}$

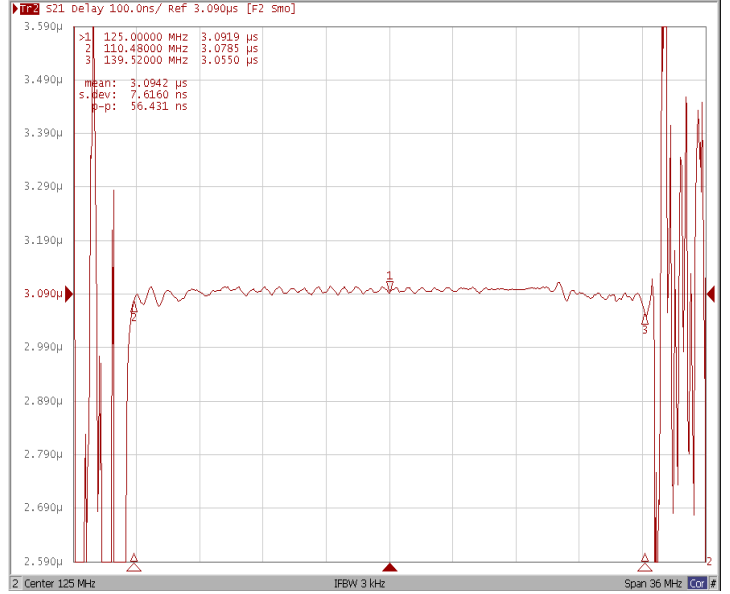

### Smith Chart

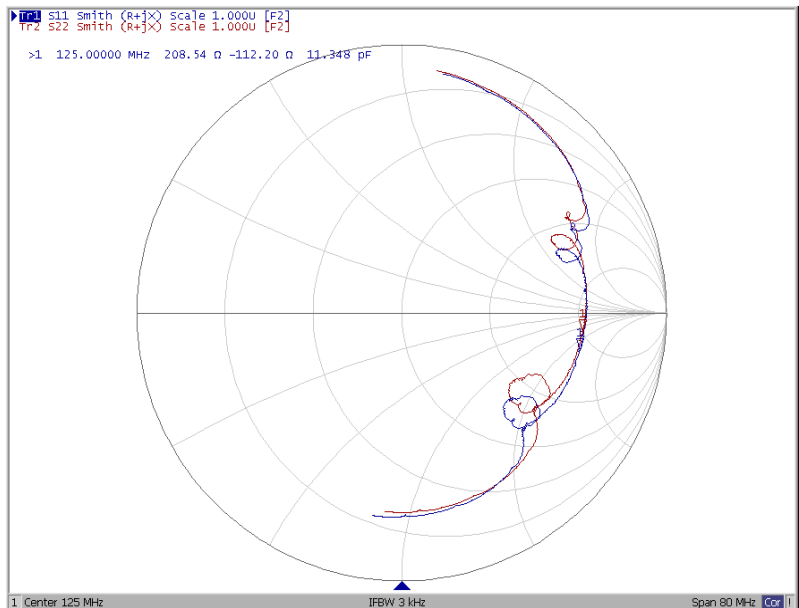



### VSWR

