



REV A January 2011

Oscilent Controlled Document

Ordering Code / Part Number	Product Description
820-IF120.0M-16A	20.0 MHz IF SAW Filter 16.13 MHz Bandwidth

Specification Contents

- o Mechanical Dimensions
- o Test Circuit
- o Maximum Ratings
- o Electrical Specification
- o Frequency Response
- o Smith Chart
- o VSWR

Notes

- o Electrostatic Sensitive Device (ESD) 
- o Avoid excessive ultrasonic exposure
- o Solderability compatible with JEDEC J-STD-020C Pb-free process, 260°C peak reflow temperature
- o This product complies with EU directive 2002/95/EC (RoHS compliance)





Mechanical Dimensions (mm)

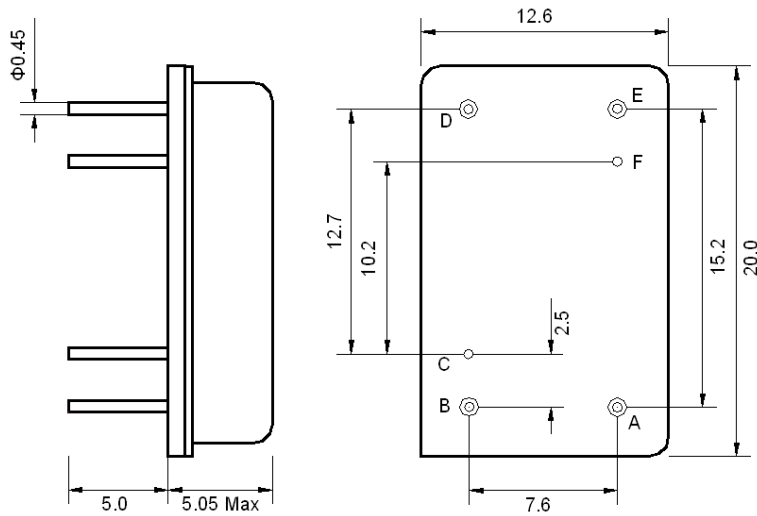

Pin Description	
B, C, D, F	Ground
A	Input
E	Output

Test Circuit

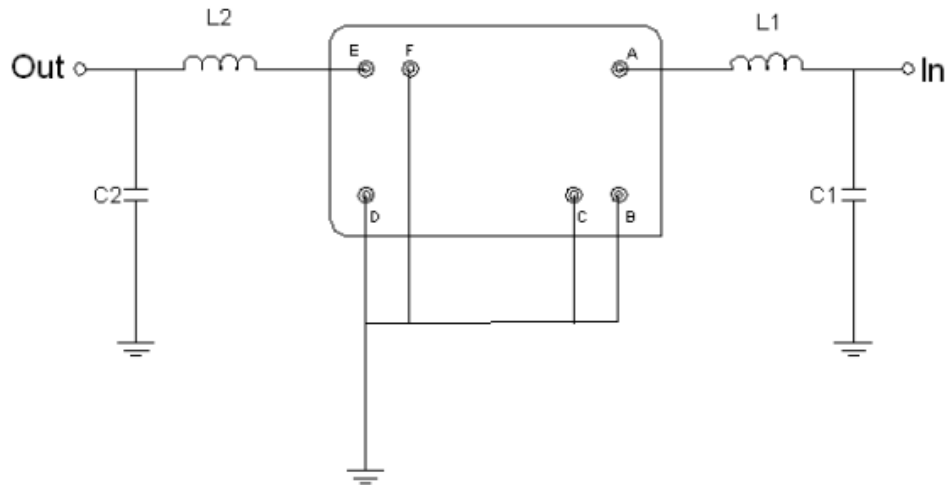

Test Fixture & Values	
Input	L1 = 56 nH, C1 = 10 pF
Output	L2 = 47 nH, C2 = 22 pF
Source/Load Impedance	50 Ω



Maximum Ratings

Parameters Description	Unit	Minimum	Typical	Maximum
Operating Temperature Range	°C	-5	-	80
Storage Temperature Range	°C	-40	-	85
Maximum DC Voltage	V	-	-	10
Maximum Input Power	dBm	-	-	10
Source Impedance (single ended) ⁽¹⁾	Ω	-	50	-
Load Impedance (single ended) ⁽¹⁾	Ω	-	50	-

Notes: With Matching Network (Ref. Testing Environment Circuit as shown above).

Those impedances could be modified with different impedance values and/or structures, if necessary.

Electrical Specification

Parameters Description	Unit	Minimum	Typical	Maximum
Center Frequency (Fo)	MHz	-	120.0	-
Insertion Loss at Fo	dB	-	21.8	23.5
Group Delay Variation at Fo ± 7.50 MHz	nsec	-	49	80
Absolute Delay at Fo	usec	-	2.27	-
Passband Ripple Variation at Fo ± 7.50 MHz	dB	-	0.58	1.00
Bandwidth at -1dB	MHz	15.95	16.13	-
Bandwidth at -3dB	MHz	-	16.48	-
Bandwidth at -40dB	MHz	-	17.88	18.00
Bandwidth at -50dB	MHz	-	18.01	-
Ultimate Rejection	dB	50	55	-
Temperature Coefficient	ppm/°C	-	-72	-



Frequency Response

Bandwidth at -1.0 dB

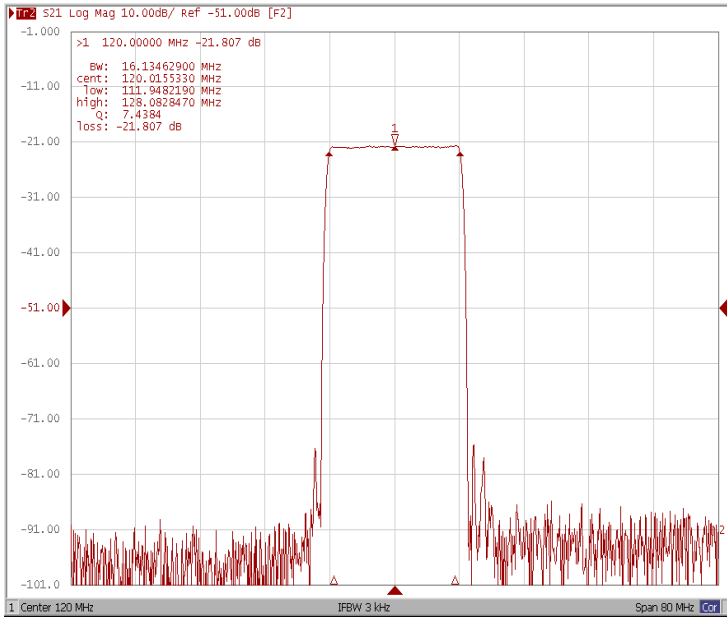

Bandwidth at -3.0 dB

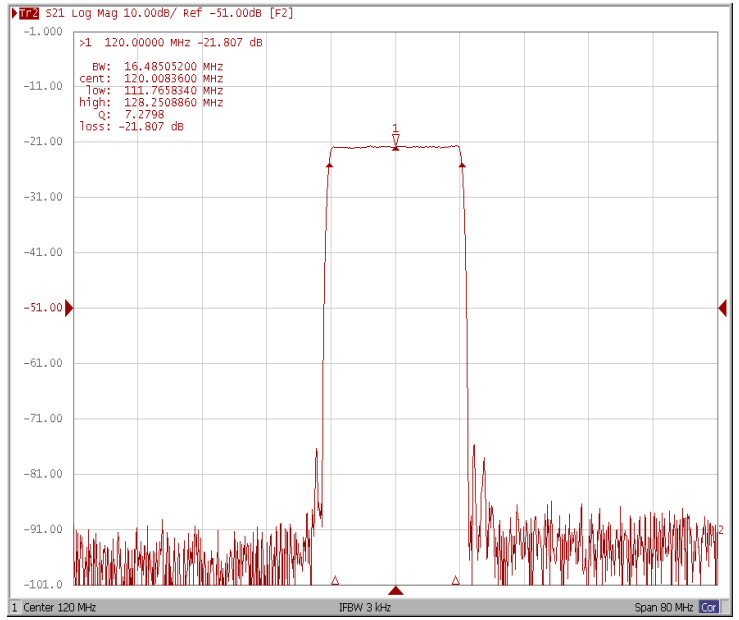

Bandwidth at -40.0 dB

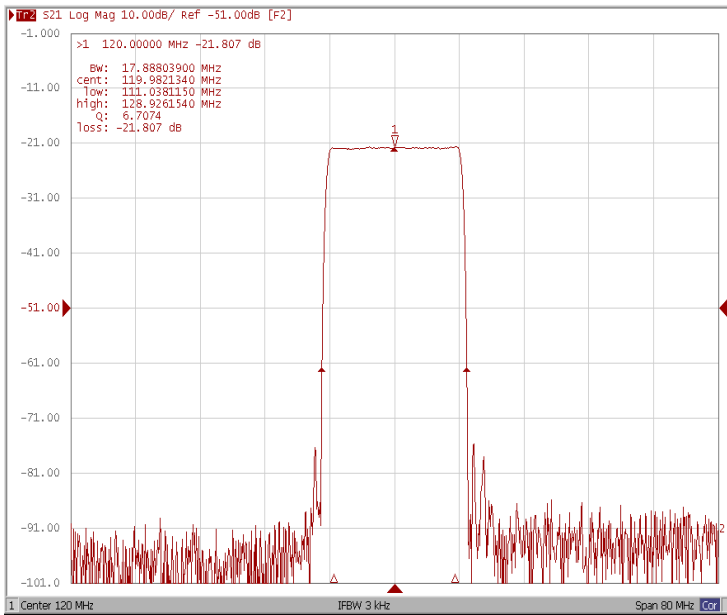

Bandwidth at -50.0 dB

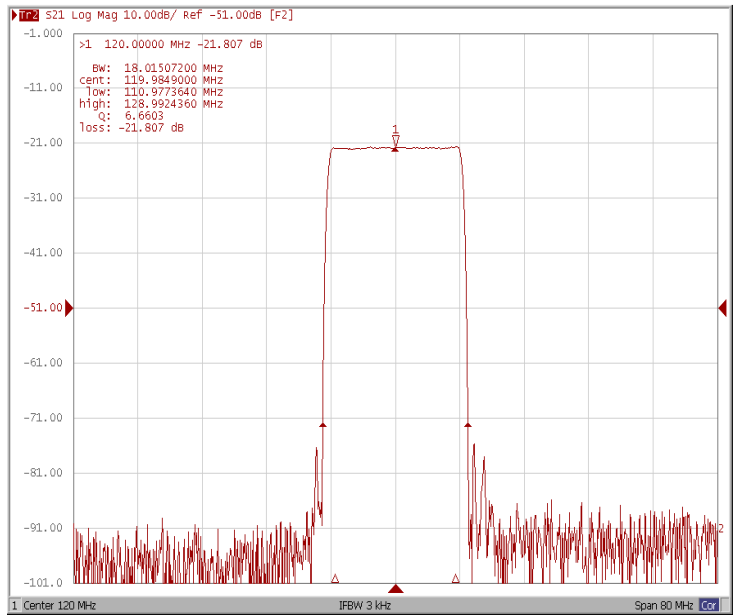



Ripple Variation Fo±7.50MHz

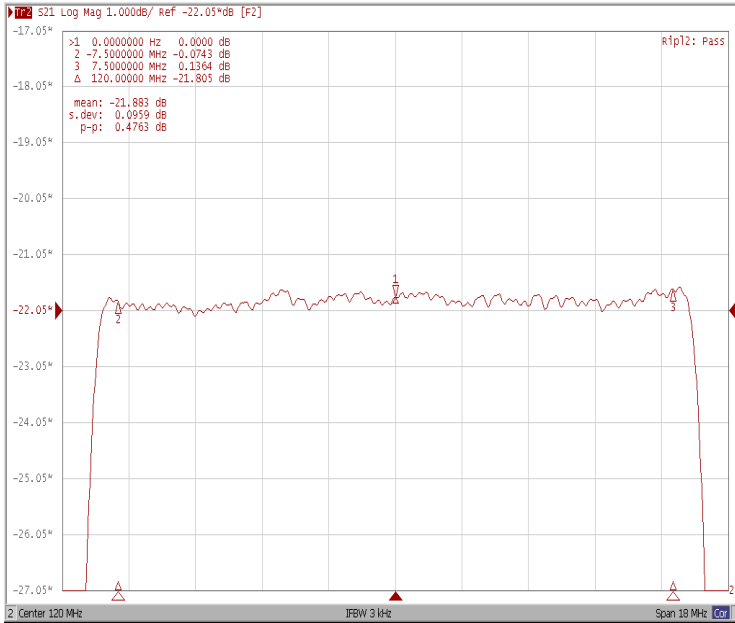

Group Delay Variation Fo±7.50MHz

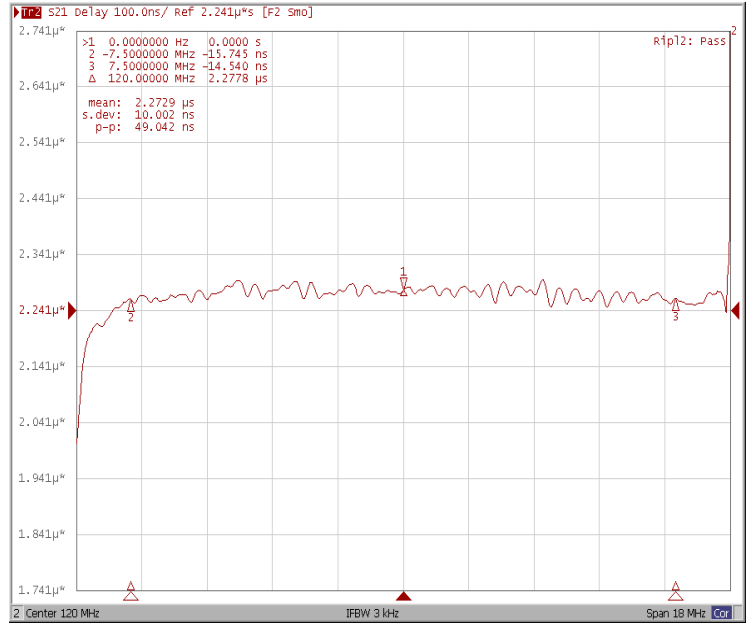

Smith Chart

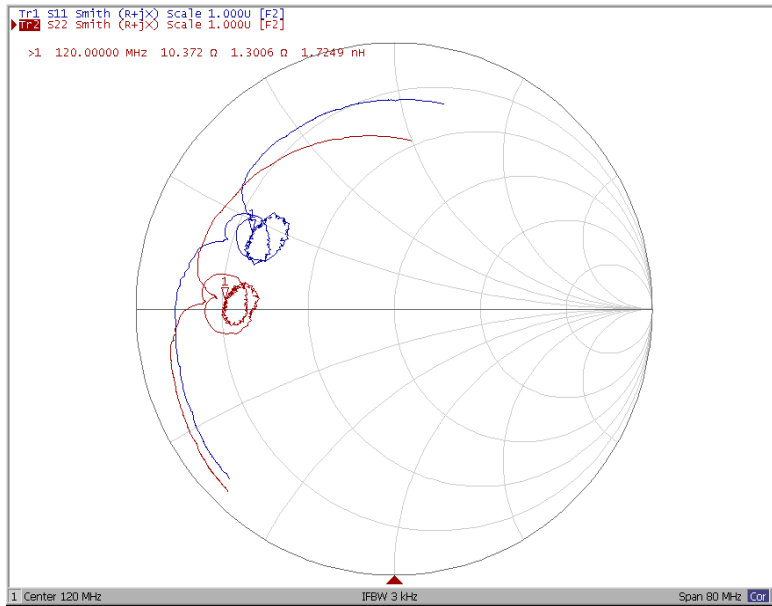



VSWR

